



Retroreflective sensor ML9-54-G/25/136/115b



- Ultra bright LEDs for power on, weak signal indication and switching state
- Flashing power on LED in case of short-circuit
- TEACH-IN
- Automatic adjustment in case of soiling in contrast detection mode
- Not sensitive to ambient light, even with switched energy saving lamps
- Protected against mutual interference (no cross-talk)
- Protection class II

Retroreflective sensor with polarization filter for clear object detection



Dimensions

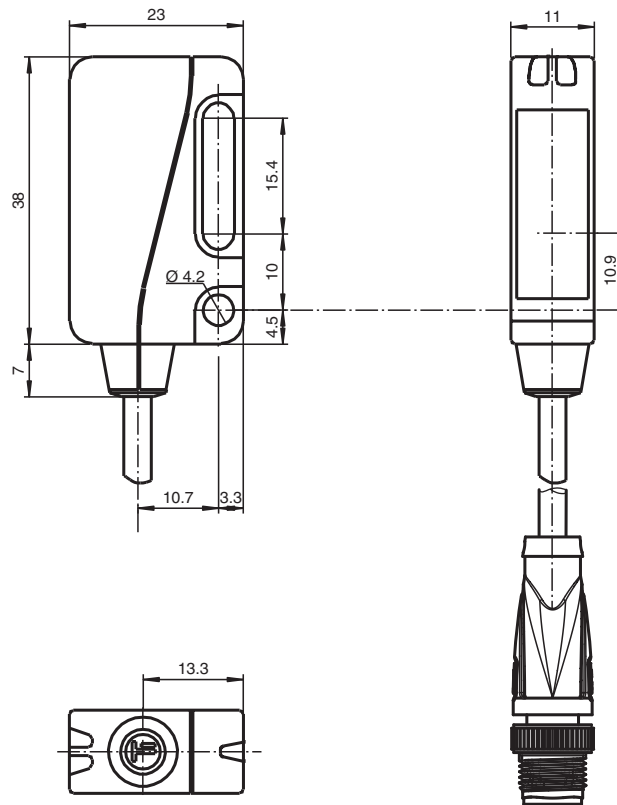

Technical Data

General specifications

Effective detection range	0 ... 3.5 m in TEACH mode 0 ... 5.7 m in normal mode
Reflector distance	0 ... 3.5 m in TEACH mode 0 ... 5.7 mm in normal mode
Threshold detection range	7.6 m

Technical Data

Reference target		H85-2 reflector
Light source		LED
Light type		modulated visible red light , 660 nm
Polarization filter		yes
Angle deviation		max. $\pm 1^\circ$
Diameter of the light spot		approx. 40 mm at detection range 1 m
Opening angle		1.7 °
Ambient light limit		40000 Lux
Functional safety related parameters		
MTTF _d		1050 a
Mission Time (T _M)		20 a
Diagnostic Coverage (DC)		0 %
Indicators/operating means		
Operation indicator		LED green, statically lit Power on , Undervoltage indicator: Green LED, pulsing (approx. 0.8 Hz) , short-circuit : LED green flashing (approx. 4 Hz)
Function indicator		LED yellow: switching state ; Operating reserve ; Teach-In
Control elements		Teach-In key
Contrast detection levels		10 % - clean, water filled PET bottles
Electrical specifications		
Operating voltage	U _B	10 ... 30 V DC , class 2
Ripple		max. 10 %
No-load supply current	I ₀	< 20 mA at 24 V DC
Output		
Switching type		light-on
Signal output		2 push-pull (4 in 1) outputs, complementary, short-circuit proof, reverse polarity protected
Switching voltage		max. 30 V DC
Switching current		max. 100 mA
Switching frequency	f	1000 Hz
Response time		500 μs
Conformity		
Product standard		EN 60947-5-2
Approvals and certificates		
Protection class		II, rated voltage ≤ 50 V AC with pollution degree 1-2 according to IEC 60664-1 functional insulation acc. to DIN EN 50178
UL approval		cULus
CCC approval		CCC approval / marking not required for products rated ≤ 36 V
Ambient conditions		
Ambient temperature		-20 ... 60 °C (-4 ... 140 °F)
Storage temperature		-40 ... 75 °C (-40 ... 167 °F)
Mechanical specifications		
Housing width		23 mm
Housing height		38 mm
Housing depth		11 mm
Degree of protection		IP67
Connection		200 mm connecting cable with 4-pin, M12x1 connector
Material		
Housing		PC (glass-fiber-reinforced Makrolon)
Optical face		glass
Mass		approx. 25 g

Connection

Option:

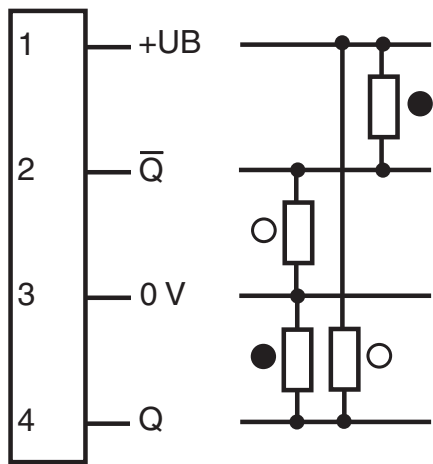

○ = Light on
● = Dark on

Connection Assignment

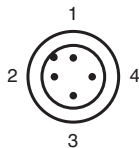

Wire colors in accordance with EN 60947-5-2

1	BN	(brown)
2	WH	(white)
3	BU	(blue)
4	BK	(black)

Assembly

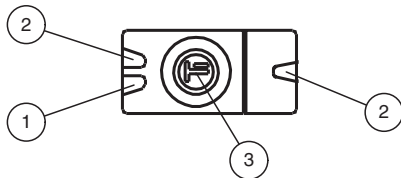

1	LED green
2	LED yellow
3	Teach-In

Release date: 2023-04-04 Date of issue: 2023-04-04 Filename: 223658_eng.pdf

Characteristic Curve

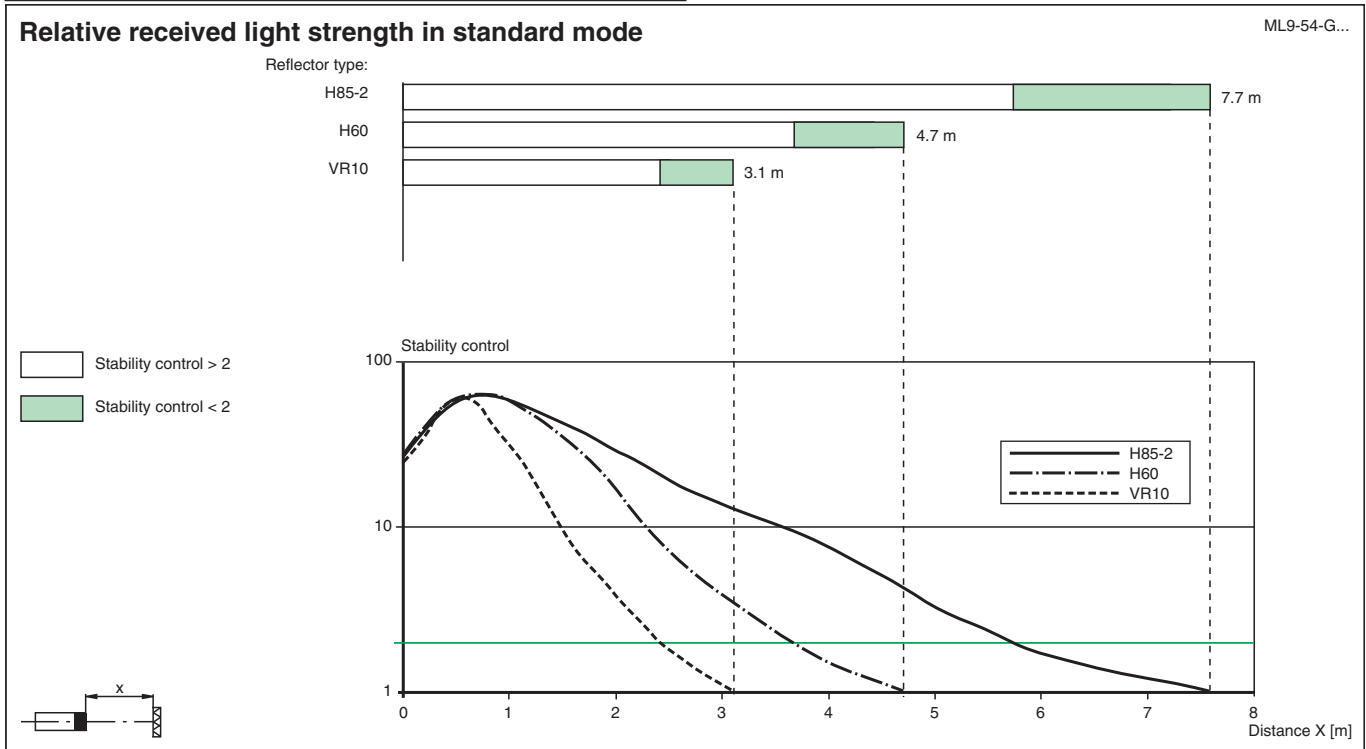
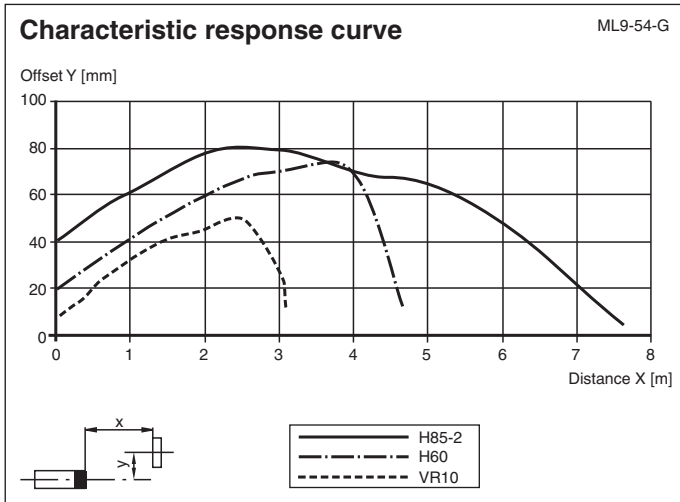

Release date: 2023-04-04 Date of issue: 2023-04-04 Filename: 223658_eng.pdf

Characteristic Curve

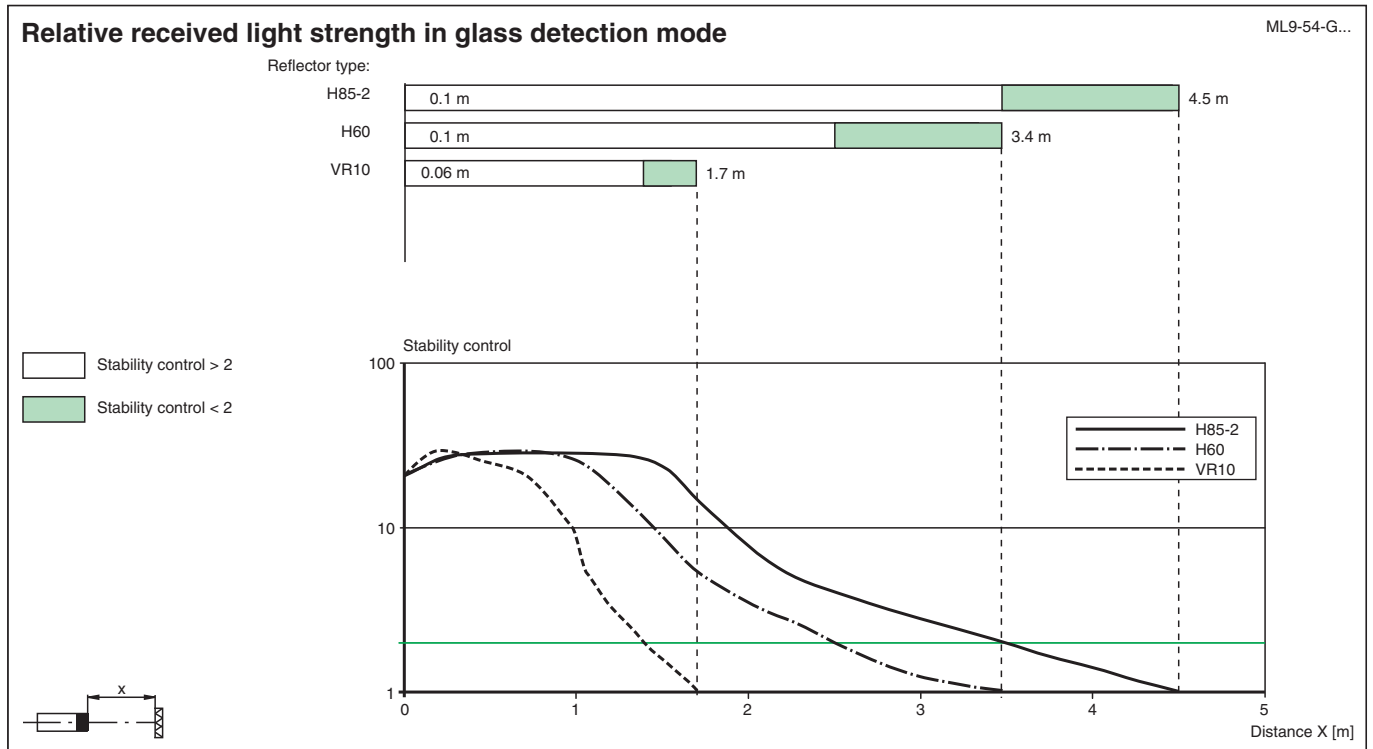

Accessories

	OMH-ML9	Mounting aid for ML9 series, Mounting bracket
	OMH-ML9-01	Mounting aid for ML9 series, Threaded bolt M3
	V1-G-2M-PUR	Female cordset single-ended M12 straight A-coded, 4-pin, PUR cable grey
	V1-W-2M-PUR	Female cordset single-ended M12 angled A-coded, 4-pin, PUR cable grey
	V1-G-5M-PUR	Female cordset single-ended M12 straight A-coded, 4-pin, PUR cable grey
	V1-W-5M-PUR	Female cordset single-ended M12 angled A-coded, 4-pin, PUR cable grey

Release date: 2023-04-04 Date of issue: 2023-04-04 Filename: 223658_eng.pdf

Adjustment instructions**Adjustment instructions for devices with Teach-In**

After the operating voltage has been applied, the LED is lit green. The sensor is automatically set to a state of maximum sensitivity (state as supplied) or the state of the most recent Teach-In setting.

Assemble the appropriate reflector opposite the light barrier.

Teach-In using the Teach key

- Align the sensor to an appropriate reflector.
- Press the Teach key - as confirmation, the green display LED is briefly turned off once.
- Hold the Teach key down until the yellow and green display LED is flashing at regular intervals (about 2.5 Hz). Then release the Teach key.
- During the internal set-up of the sensor, the green and yellow display LEDs flash alternately (about 2.5 Hz).
- Teach-In successful: The green and yellow display LEDs are lit. Contrast detection 10% is activated. The device is ready for operation.
- Teach-In not successful: The green and yellow display LEDs flash alternately and rapidly (about 8 Hz) for about 5 seconds. Then the sensor goes to the state with maximum sensitivity. After this happens, repeat the Teach-In procedure, starting with step 1.