

Optical data coupler

LS610-DA-IBS/F2/35/146

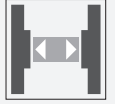

- Devices for INTERBUS
- Version for low temperature applications
- Plug connection for fast mounting
- No parameterization
- Usable up to detection range 0
- Line indicator for signal strength

Optical data coupler for INTERBUS, 240 m detection range, infrared light, M12 plug, low temperature version



Dimensions

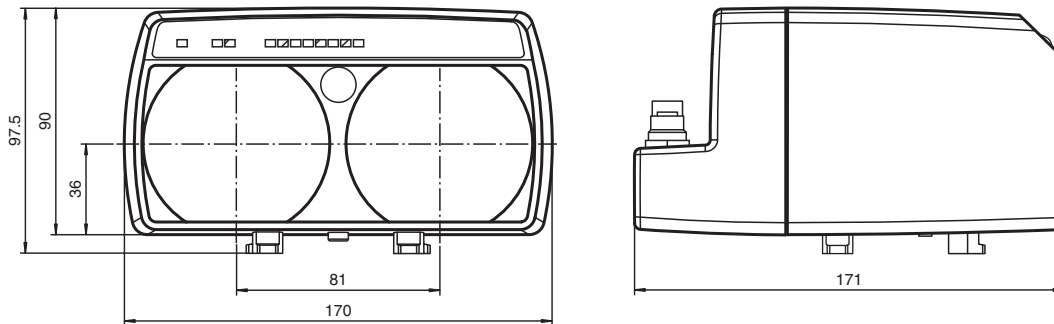

Remote Bus IN
Connector M12 x 1, 5-pin
B-coded

Remote Bus OUT
Socket M12 x 1, 5-pin
B-coded

Power
Connector M12 x 1, 4-pin

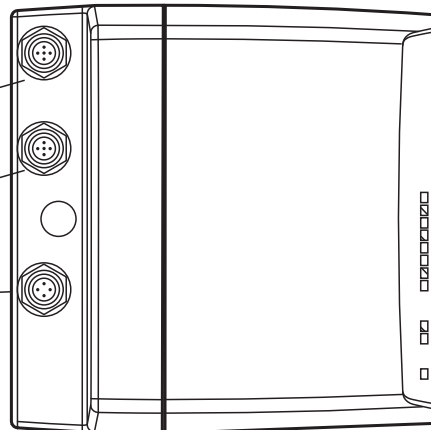

Technical Data

General specifications		
Effective detection range		0 ... 240 m
Threshold detection range		260 m
Light type		modulated infrared light
Diameter of the light spot		2 m at a distance of 100 m
Opening angle		1.1 °
Ambient light limit		> 10000 Lux
Functional safety related parameters		
MTTF _d		260 a
Mission Time (T _M)		20 a
Diagnostic Coverage (DC)		0 %
Indicators/operating means		
Data flow indicator		LED green: emitter LED yellow: receiver
Function indicator		alignment aid: flashing front red LED Signal strength (8 LED: Red, yellow, green)
Electrical specifications		
Operating voltage	U _B	18 ... 30 V DC
No-load supply current	I ₀	200 mA
Data rate		0 ... 2 MBit/s
Operation frequency		F2 = 12.5 MHz
Interface		
Interface type		RS 422 , galvanically isolated
Output		
Stability alarm output		1 PNP (switches if there is sufficient stability control) short-circuit protected, max. 200 mA
Conformity		
Product standard		EN 60947-5-2
Approvals and certificates		
Approvals		CE, cULus
Ambient conditions		
Ambient temperature		-30 ... 50 °C (-22 ... 122 °F) , For use in dry cold
Storage temperature		-30 ... 70 °C (-22 ... 158 °F)
Mechanical specifications		
Degree of protection		IP65
Connection		4-pin, M12x1 connector, standard (supply) , 5-pin, M12x1 connector, B-coded (Remote Bus In) , 5-pin, M12x1 socket, B-coded (Remote Bus Out)
Material		
Housing		ABS / PC
Optical face		plastic
Mass		700 g



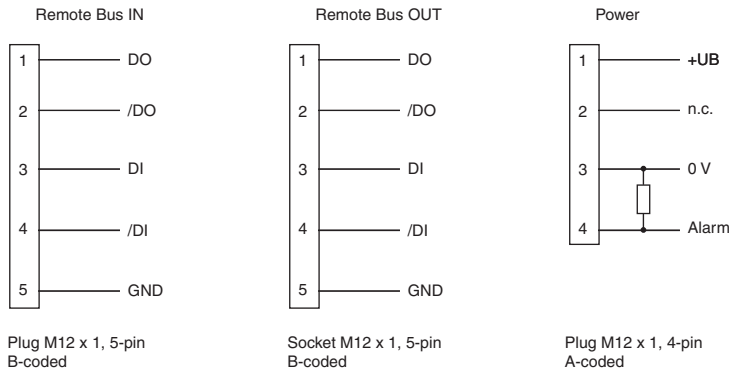

Connection Assignment

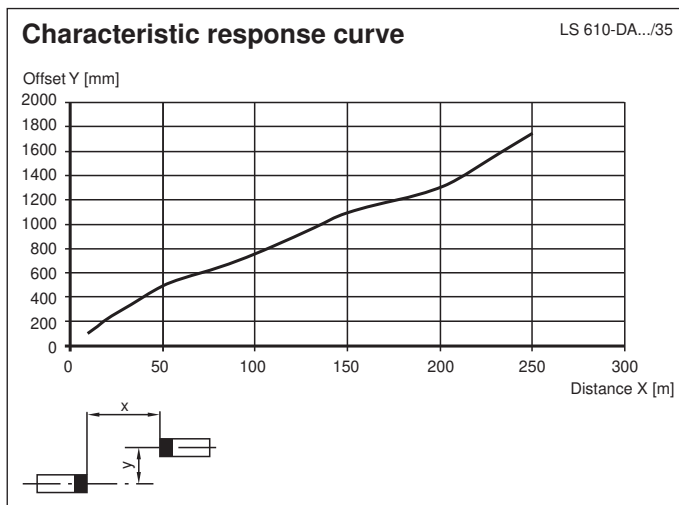

Characteristic Curve







Accessories

	V15-G-PG9	Female connector M12 straight A-coded 5-pin, for cable diameter 6 - 8 mm, field-attachable
	Funktionserdung LS610/VDM100 Zubehoer	Function grounding for LS610 / LS611 / VDM100 series
	Schutzkappe LS610 Zubehoer	M12 protective cap set (connector + socket) for series LS610 / LS611
	OMH-LS610-01	Mounting bracket for optical data coupler

Release date: 2023-03-28 Date of issue: 2023-03-28 Filename: 225080_eng.pdf

Accessories

	OMH-LS610-01	Mounting bracket for optical data coupler
	OMH-LS610-02	Direct mounting set consisting of 4 x M4 threaded inserts
	OMH-LS610-03	Mounting bracket with deviation mirror for optical data coupler
	OMH-LS610-32	Mounting bracket for optical data coupler and distance measurement devices

Additional Information

Product description

The LS610-DA-IBS is a device for serial data transmission in INTERBUS systems with transmission rates of up to 2 MBit/sec and ranges up to 240 m. For data rates and operating ranges lower than these values, the device can also be used with no problems. For one data transmission connection, an LS 610-DA-IBS unit with a mean frequency of F1 **and** an LS 610-DA-IBS unit with mean frequency F2 are required.

The LS610-DA-IBS is intended for the direct connection of Interbus S units ("extension of bus cables"). It contains no bus connection logic, and is thus not suited for spur line installations. For this reason, only one of the M12 connectors should be used at a time.

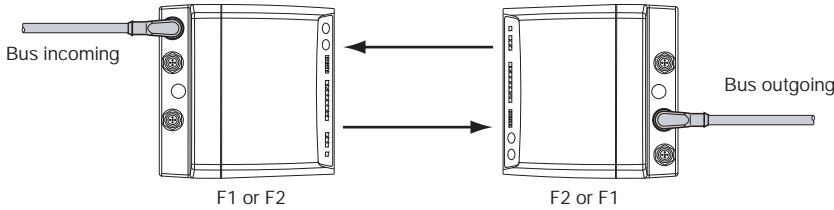

Data transmission

Data is transmitted in both directions using modulated infrared light. The information carried on the incoming bus is modulated on the carrier signal in real time using frequency shift keying (FSK). In the receiver, the corresponding demodulation is performed and the data is output on the outgoing bus. The complete transmission process is performed using no protocols.

The LS610 DA-IBS includes level-type regeneration as well as complete voltage isolation of the data transmission circuits from the power supply.

Function displays/function reserves

For alignment, there is an alignment LED on the unit's face which is visible from a distance. As soon as a receiver detects the transmission light of the opposite unit, the blink frequency of the alignment aid is lowered. When it is extinguished, this signals that the units are optimally aligned with one another, and enough functional reserve is available. For fine adjustment, the data system is equipped with a bar graph display (signal display) which enables optimal alignment.

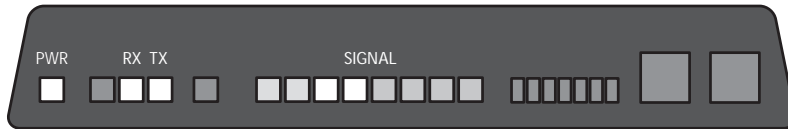

State	weak signal	sufficient signal strength	signal with function reserve
Transmission	blocked	released	transmission with function reserve
Alignment-LED	fast flashing	slow flashing	off
Signal-indicator	red area	yellow area (at least one LED)	green area

Connection between display and operational status

If the bus is active, a yellow LED "RX" is lit for received data and a green LED "TX" for transmitted data.

Installation

Installation is done with the corresponding accessories, for instance, OMH-LS610-01 for wall mounting.

The x/y adjustment is premounted at the factory. It is fastened to the mounting bracket in the desired transmission direction ($\pm 90^\circ$ rotation possible) with the two M4 screws and a central M6 screw. The middle screw is for fastening after adjustment and should only be tightened afterwards.

The data photo sensor is inserted into the notches of the adjustment device while holding both of the front bolts together with holding tabs. After insertion, the bolts are released and hold the unit securely by springing back.

Using the two adjustment screws (Inbus 5 mm), the transmission axis can now be directed in the X and Y directions, and the adjustment fixed in place by tightening the middle screw.

Release date: 2023-03-28 Date of issue: 2023-03-28 Filename: 225080_eng.pdf