

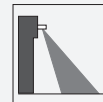

## Radar sensor RaDec-D Silver



- Microwave motion sensor with intelligent functions
- Reliable detection of people and vehicles
- Simplest adjustment of the sensing range
- Wall and ceiling mountable
- Version with direction detection and cross-traffic suppression

Standard radar motion sensor with additional functions, dynamic version with rotation direction monitoring, detection range 2 m x 4.5 m, max. installation height 4 m, silver housing, relay contact output, cable connection



### Function

The RaDec series consists of affordable radar motion sensors that not only combine all the key requirements of door manufacturers in a compact, stylish device, but are also user friendly and easy to install. An integrated microprocessor with 24 GHz microwave technology ensures a high level of reliability, even in difficult conditions. What's more, the sensor offers two adjustable detection areas, different operating modes, and an installation height of up to 4 m, and operates in a temperature range of -20 °C ... +60 °C. The -D version features rotation direction monitoring; a cross-traffic suppression system can also be connected to this version.

**Dimensions**

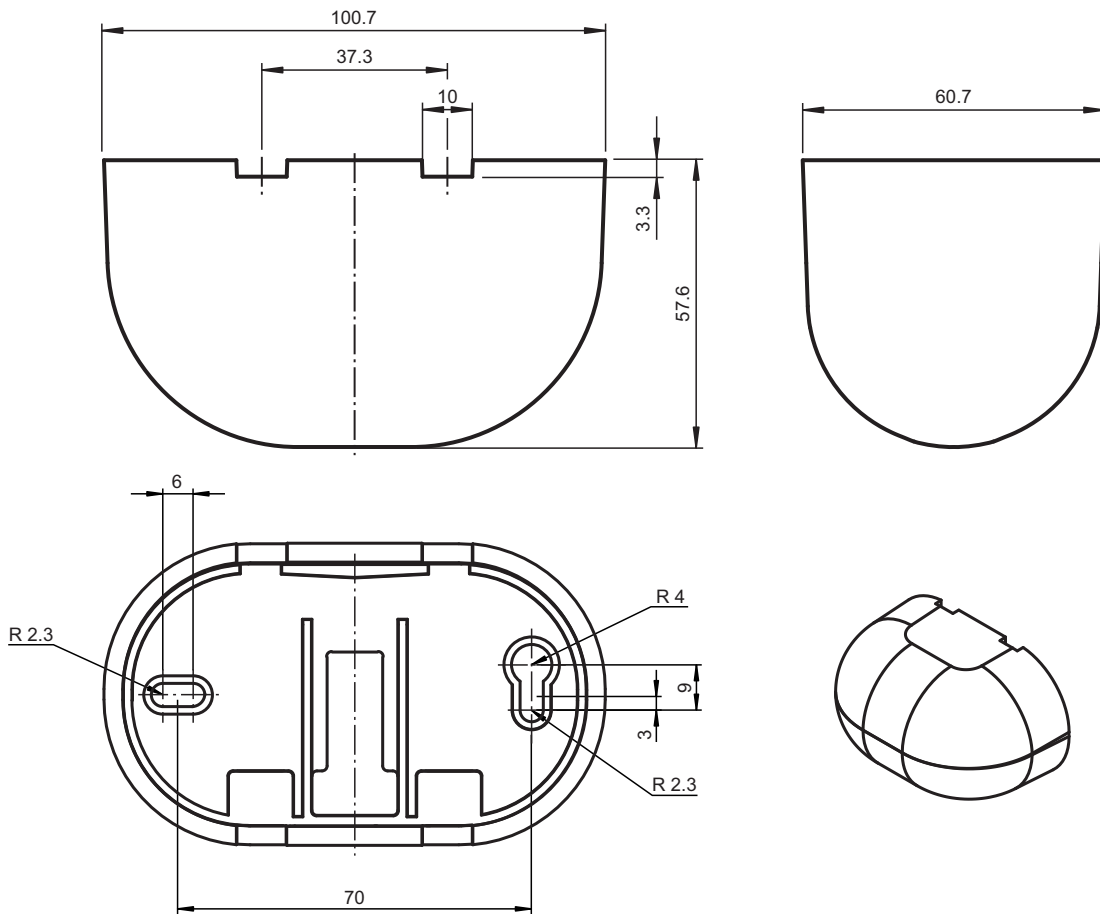

**Technical Data**

<b>General specifications</b>	
Sensing range	Wide: 2000 x 4500 mm (DxW) at 2200 mm mounting height and 30° inclination angle narrow: 4500x 2000 mm (DxW) at 2200 mm mounting height and 30° inclination angle
Function principle	Microwave module
Detection speed	min. 0.1 m/s
Setting angle	0 ... 90 ° in 5 ° increments
Operating frequency	24.15 ... 24.25 GHz K-Band
Operating mode	Radar motion sensor
Transmitter radiated power (EIRP)	< 20 dBm
<b>Functional safety related parameters</b>	
MTTF <sub>d</sub>	300 a
Mission Time (T <sub>M</sub> )	20 a
Diagnostic Coverage (DC)	0 %
<b>Indicators/operating means</b>	
Function indicator	LED red
Control elements	potentiometer , DIP switch for selection of operating modes
Control elements	sensitivity adjustment
<b>Electrical specifications</b>	
Operating voltage	U <sub>B</sub> 12 ... 36 V DC , 12 ... 28 V AC
No-load supply current	I <sub>0</sub> ≤ 50 mA at 24 V DC
Power consumption	P <sub>0</sub> ≤ 1.7 W
<b>Output</b>	

Release date: 2023-03-28 Date of issue: 2023-03-28 Filename: 225574\_eng.pdf

## Technical Data

Switching type		NO/NC
Signal output		relay
Switching voltage		max. 48 V AC / 48 V DC
Switching current		max. 0.5 A AC / 1 A DC
Switching power		max. 24 W / 60 VA
De-energized delay	t <sub>off</sub>	1 s
<b>Approvals and certificates</b>		
CE conformity		2014/53/EU This device can be used in all countries within the European Union. In other countries, all applicable national regulations must be observed.
FCC approval		No - Use in North America is not permitted.
<b>Ambient conditions</b>		
Operating temperature		-20 ... 60 °C (-4 ... 140 °F)
Storage temperature		-30 ... 70 °C (-22 ... 158 °F)
Relative humidity		max. 90 % non-condensing
<b>Mechanical specifications</b>		
Mounting height		max. 4000 mm
Degree of protection		IP54
Connection		Connecting cable 2.5 m included with delivery
Material		
Housing		Polycarbonate (PC), silver painted
Mass		130 g
Dimensions		101 mm x 60 mm x 59 mm
<b>Suitable series</b>		
Series		RaDec

## Connection Assignment

Option:

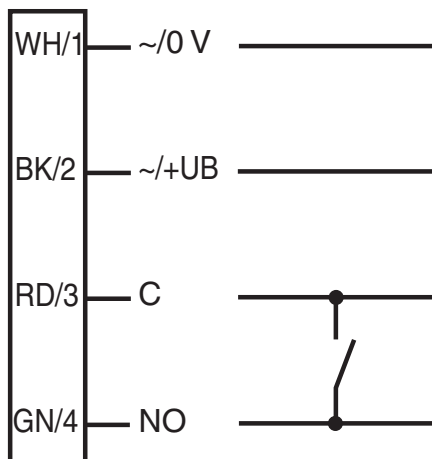

## Assembly

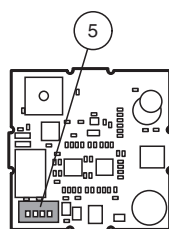
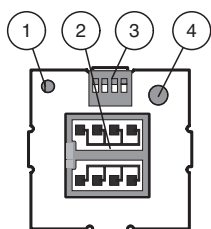



1	LED red
2	Antenna
3	DIP switch
4	Potentiometer
5	Connector

## Application



## Accessories

	<b>RaDec Weather Cap Silver</b>	Weather hood for radar sensors series RaDec
	<b>RMS/RaDec Ceiling Kit wh</b>	Ceiling mount kit for radar sensors in the RMS and RaDec Series

**Function**

**Detection area**

A wide or narrow detection area can be set by turning the PCB.

Detection area wide (Standard)

Detection area narrow

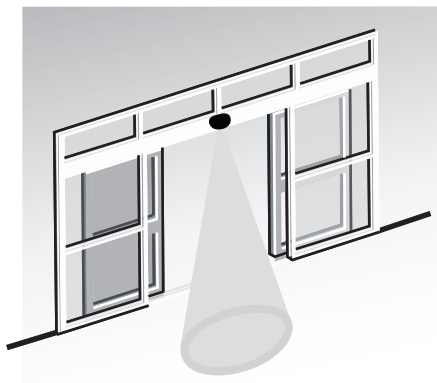
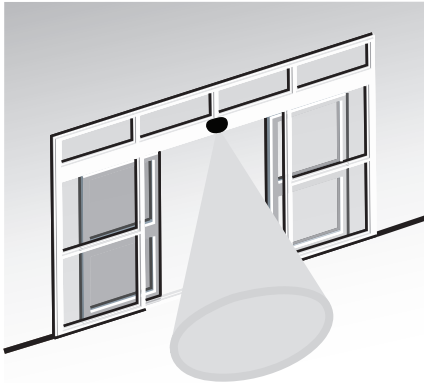

The size of the detection area can be changed using the potentiometer.

With the standard locking discs (already fitted in supplied device) you can set the position of the inclination angle in 10° or 5° increments from 0° to 90°.

By using the supplied locking discs for an inclined detection area (e.g. in revolving doors) the detection field can be rotated 15° left or right.

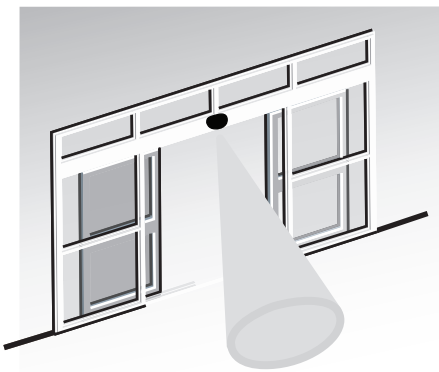

**Detection capabilities**

Direction detection

With direction detection, it can be set whether the sensor should be triggered by forward movements only or by forward and backward movements.

Cross-traffic suppression

Cross traffic suppression allows for passers-by to be partially suppressed.

Immunity

Immunity allows various external interferences, e.g. rain, vibrations and reflections to be minimized.

Relay contact switching mode

Relay contact when detection is active (NO)

Relay contact when detection is passive (NC)

The setting of the detection capabilities takes place with the DIP switch. The settings are checked by walking in the sensing area.

**Function Principle**

Radar sensors are microwave sensors that adopt the principle of Doppler radar. The most important requirement for microwave detection is that the object to be detected is moving. Applications include controlling automatic doors and gates.

The sensor emits microwaves of a defined frequency in order to detect people and large objects moving at speeds between 100

Release date: 2023-03-28 Date of issue: 2023-03-28 Filename: 225574\_eng.pdf

mm/sec. and 5 m/sec. Stationary people or objects are not detected. Based on the latest 24 GHz technology with integrated microprocessor control, these sensors provide a high level of reliability, even in difficult operating conditions. The 24 GHz frequency, known as the 'K-band,' is reserved by CETECOM for this application area worldwide.

The direction detection function makes it possible to distinguish whether persons are moving towards the door or away from it. It is necessary to trigger the opening impulse if people are approaching the door. The sensor ignores objects that are moving away. Cross-traffic suppression serves a similar purpose. Automatic doors are often opened when a pedestrian walks too close to a shop window or a building facade. The cross-traffic suppression function can avoid this, because microwave technology combined with the microprocessor evaluation unit accurately detects these directions of motion. Both functions noticeably quiet the door area, increase the lifetime of the door mechanism, and in doing so help save energy.

## Application

- Opening impulse sensors for automatic doors and industrial doors
- Monitoring approach areas to elevators
- Motion sensors for people and objects
- Impulse sensors for escalators