



## Valve Connector Cordset VMA-2+P-2M-PUR

- Valve connector according EN 175301-803 A/ISO 4400
- Moulded seal
- Suitable for drag chains and abrasion resistant
- freely selectable cable models due to bridged protective earth
- Flame resistant cable
- Halogen-free
- Oil resistant
- Immunity to vibration

Valve connector Form A, 2-pin+PE, PUR cable black, drag chain suitable



### Dimensions

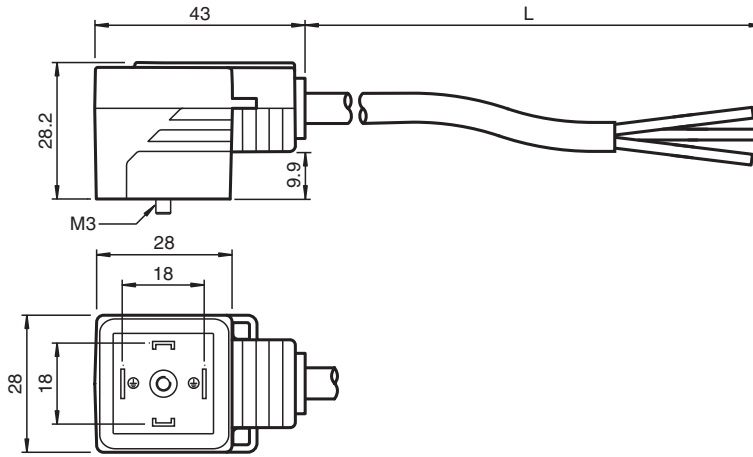

### Technical Data

General specifications			
Connector 1			
Connection		Valve connector DIN	
Construction type		form A	
Style		angled	
Locking		screw connection	
Number of pins		2 + PE	
Connector 2			
Connection		cable end	
Customization		sheath stripped 50 mm	
Electrical specifications			
Operating voltage	$U_B$	max. 230 V AC/DC	
Operating current	$I_B$	max. 6 A	
Conformity			
Degree of protection		EN 60529	
Plug connection		Valve connector : DIN EN 175301-803	
Flammability		DIN VDE 0482 , DIN EN 50265-2-1 , UL 94	

Release date: 2025-02-09 Date of issue: 2025-02-09 Filename: 226473\_eng.pdf

## Technical Data

Halogen-free		DIN VDE 0472-815
UV resistance		DIN EN ISO 4892-2-A
Oil resistance		DIN EN 60811-2-1
<b>Ambient conditions</b>		
Ambient temperature		
Plug connector		-20 ... 85 °C (-4 ... 185 °F)
Cable, fixed installation		-40 ... 80 °C (-40 ... 176 °F)
Cable, flexing		-20 ... 80 °C (-4 ... 176 °F)
Pollution degree		3
<b>Mechanical specifications</b>		
Plug connector		
Tightening torque		0.6 Nm
Tool installation		screw M3 x 29
Mating cycles		min. 100
Degree of protection		IP65 / IP67
Cable		
Sheath diameter		4.5 mm
Bending radius		> 10 x cable diameter, movable installation > 5 x cable diameter, fixed installation
Sheath color		black (similar to RAL 7021)
Number of cores		3
Core cross section		0.5 mm <sup>2</sup>
Cores color		Core 1: black 1 Core 2: black 2 Core PE: green/yellow
Core construction		28 x 0.15 mm Ø
Length	L	2 m
Cable code		Li 9Y 11Y 3 x 0,50
Drag chain suitability		
Drag chain cycles		min. 15000000
Motion velocity		max. 5 m/s
Traverse distance		0.9 m
Acceleration		max. 30 m/s <sup>2</sup>
Mass		91 g
<b>Material</b>		
Halogen-free		yes
Plug connector		
Body		TPU, black
Seal		TPU , molded
Contact surface		Sn
Flammability		V-0
Cable		
Sheathing		PUR
Cores		bare copper (Cu)
Core insulation		PP
UV resistance		yes
Oil resistance		good
Flammability		V-0

Release date: 2025-02-09 Date of issue: 2025-02-09 Filename: 226473\_eng.pdf

Connection

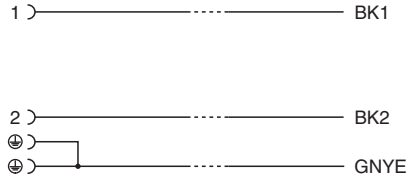
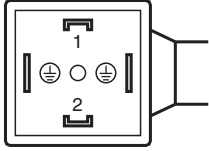

Release date: 2025-02-09 Date of issue: 2025-02-09 Filename: 226473\_eng.pdf