



Retroreflective area sensor RLG28-55-4921/115b/136



- Retro-reflective area sensor with 6 light beams in standard photoelectric-sensor enclosure
- Connection compatibly replaces single beam photoelectric sensor
- Reliable detection of the front edge of the object irrespective of its shape and position
- Constant object detection from 12 mm within the entire detection area
- Reliable detection of all surfaces irrespective of the object texture
- Switches when contrast difference 10%
- Bright, highly visible transmitter beams guarantee convenient alignment of the sensor

Retroreflective area sensor with 6 beams in a widely used standard photoelectric housing, red light, 4 m detection range, light/dark on, push-pull output, fixed cable with M12 plug



Function

The RLG28 retro-reflective area sensor contains several transmitters and receivers in one housing and with a reflector positioned opposite forms a 60 mm detection area over a sensing range of 4 m. When the light beams are interrupted by an object, the switching function is triggered. The smallest detectable object size is 12 mm. The RLG28 switches at a 10% contrast difference with a response time of 1 ms. An intelligent gain control compensates for effects such as dirt, misalignment, and temperature.

Dimensions

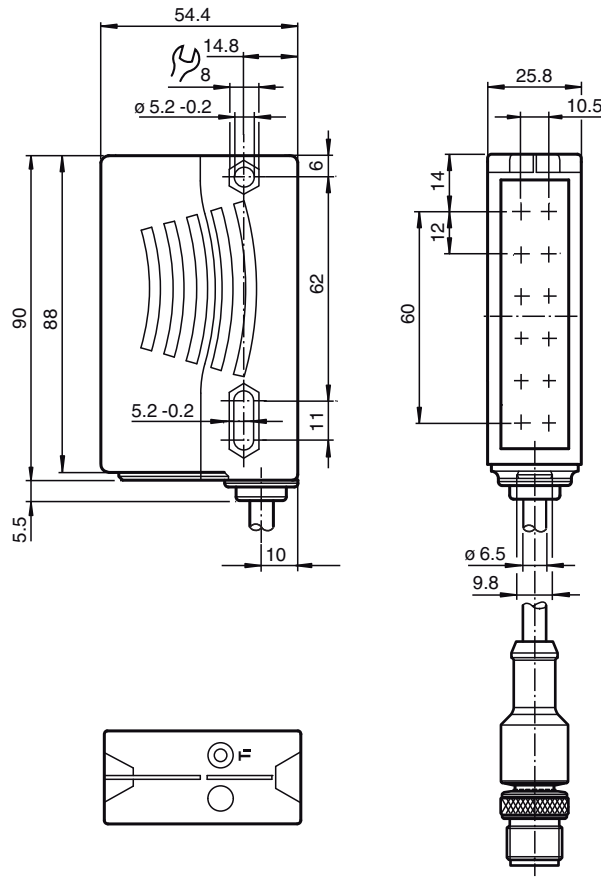

Technical Data

General specifications	
Effective detection range	0 ... 4 m
Reflector distance	Reflector A80: 0.4 ... 4 m , H85-2 reflector: 0.2 ... 4 m , Foil reflector OFR-100/100: 0.4 ... 3 m
Threshold detection range	5.6 m
Sensing range	typical 60 mm , Object has to cover the reflector completely in one dimension
Reference target	Reflector A80 H85-2 reflector Foil reflector OFR-100/100
Light source	LED
Light type	modulated visible red light , 625 nm
Polarization filter	yes
Number of beams	6
Diameter of the light spot	approx. 220 mm at detection range 4 m
Opening angle	+/- 2.5 °
Ambient light limit	5000 Lux
Resolution	12 mm to 4 m Detection/capture range: 60 mm (no dead band) 5 mm to 1 m Detection/capture range: 55 mm (dead band: 150 mm in front of the sensor; 50 mm in front of the reflector) 5 mm to 1.5 m Detection/capture range: 40 mm (dead band: 150 mm in front of the sensor; 50 mm in front of the reflector)
Functional safety related parameters	
MTTF _d	310 a
Mission Time (T _M)	20 a

Release date: 2023-03-28 Date of issue: 2023-03-28 Filename: 227581_eng.pdf

Technical Data

Diagnostic Coverage (DC)	0 %	
Indicators/operating means		
Operation indicator	LED green, statically lit Power on Undervoltage indicator: Green LED, pulsing (approx. 0.8 Hz) short-circuit : LED green flashing (approx. 4 Hz)	
Function indicator	2 LEDs yellow, light up when light beam is free, flash when falling short of the stability control, off when light beam is interrupted Teach-In : LED yellow/green; equiphase flashing; 2,5 Hz Changeover signal tracking: LED yellow, 1 Hz flashing / 2x flashing	
Control elements	Teach-In key	
Electrical specifications		
Operating voltage	U_B	12 ... 30 V DC
Ripple		max. 10 %
No-load supply current	I_0	max. 50 mA
Output		
Switching type	light/dark on	
Signal output	2 push-pull (4 in 1) outputs, complementary, short-circuit proof, reverse polarity protected	
Switching voltage	max. 30 V DC	
Switching current	max. 100 mA	
Voltage drop	U_d	≤ 2.5 V DC
Switching frequency	f	230 Hz
Response time	1 ms	
Conformity		
Product standard	EN 60947-5-2	
Approvals and certificates		
UL approval	cULus Listed, Class 2 Power Source	
CCC approval	CCC approval / marking not required for products rated ≤ 36 V	
Ambient conditions		
Ambient temperature	-10 ... 40 °C (14 ... 104 °F) -30 ... 60 °C (-22 ... 140 °F) at active signal tracking	
Storage temperature	-40 ... 70 °C (-40 ... 158 °F)	
Mechanical specifications		
Housing width	25.8 mm	
Housing height	88 mm	
Housing depth	54.3 mm	
Degree of protection	IP67	
Connection	300 mm fixed cable with M12 x 1, 4-pin connector	
Material		
Housing	Plastic ABS	
Optical face	Plastic pane	
Mass	100 g	

Connection Assignment

Option:

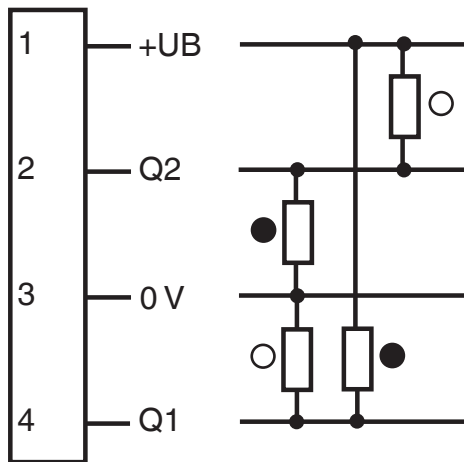

- = Light on
- = Dark on

Connection Assignment

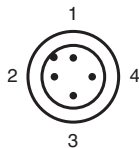

Wire colors in accordance with EN 60947-5-2

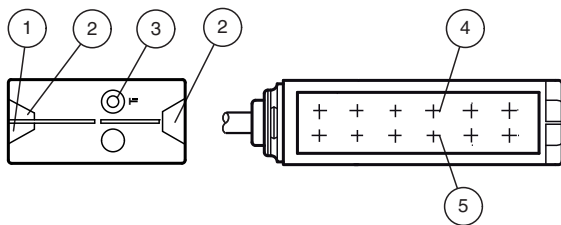

- | | | |
|---|----|---------|
| 1 | BN | (brown) |
| 2 | WH | (white) |
| 3 | BU | (blue) |
| 4 | BK | (black) |

Assembly









1	Operating display	green
2	Signal display	yellow
3	TEACH-IN button	
4	Emitter	
5	Receiver	

Accessories

	OMH-05	Mounting aid for round steel \varnothing 12 mm or sheet 1.5 mm ... 3 mm
	OMH-21	Mounting bracket: mounting aid for sensors in the RL* series

Release date: 2023-03-28 Date of issue: 2023-03-28 Filename: 227581_eng.pdf

Accessories

	OMH-RLK29-HW	Mounting bracket for rear wall mounting
	OMH-K01	dove tail mounting clamp
	REF-H85-2	Reflector, rectangular 84.5 mm x 84.5 mm, mounting holes
	V1-G-2M-PVC	Female cordset single-ended M12 straight A-coded, 4-pin, PVC cable grey
	V1-G-2M-PUR	Female cordset single-ended M12 straight A-coded, 4-pin, PUR cable grey
	V1-W-2M-PUR	Female cordset single-ended M12 angled A-coded, 4-pin, PUR cable grey
	REF-A80	Reflector, rectangular 80 mm x 50 mm, self-adhesive

Additional Information

Mounting:

Ensure that the red light transmitted by the sensor fully illuminates the reflector. To ensure optimal detection, the entire 60 mm detection field must appear on the reflector. To check this illumination, look at the reflector from over the top of the sensor housing.

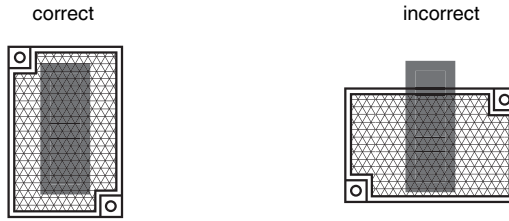

Teach-in:

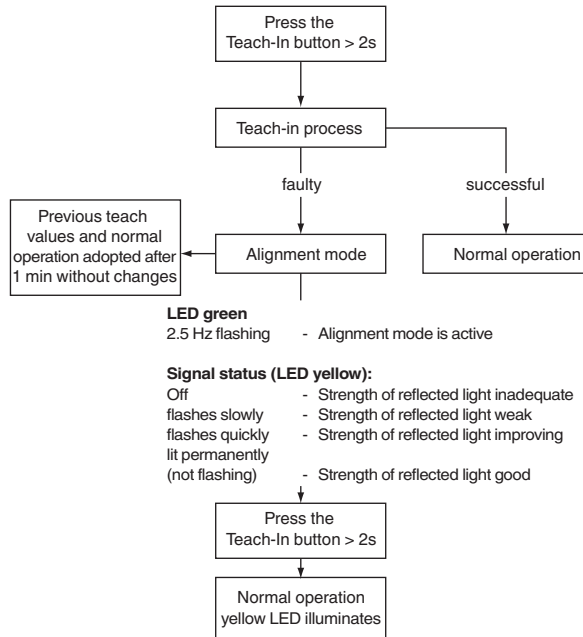

More stringent adjustment requirements: Ensure that the device is correctly aligned in the near range of 0.2 m ... 0.6 m.

Object detection after successful Teach-in

The target should be large enough so that the reflector is always completely covered in one dimension!

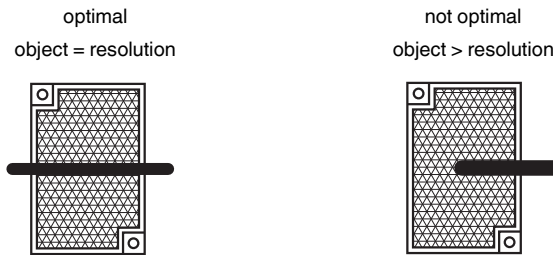

Signal tracking:

Active:

- At variable temperature
- Objects located in the light path that lie below the switching point. These objects result in a readjustment of the emitter. This allows these objects to be taught in or taught out.

Inactive:

- Function not available

To alter the signal tracking, press the Teach-in button for > 10 seconds. The current status is displayed. Briefly pressing the Teach-in button changes the mode.

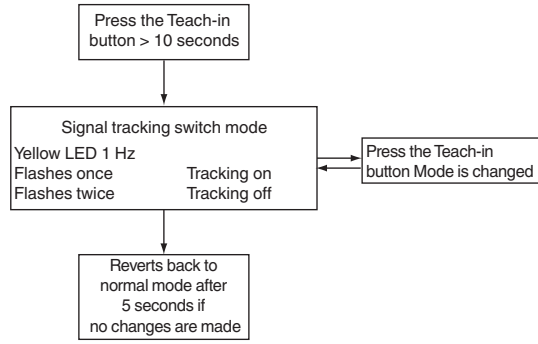

Release date: 2023-03-28 Date of issue: 2023-03-28 Filename: 227581_eng.pdf