

Connection cable

V1-W-E8W-OR2M-POC-V1-G



- Built-in LED, as operating and function indicator
- Welding-bead resistant
- Suitable for robotic applications / torsion resistant
- Degree of protection IP68 / IP69
- Free of paint wetting interfering substances
- Ozone resistant
- Hydrolysis resistant
- Oil resistant
- Halogen-free
- Specific design protects against loosening and inaccurate installation

Cordset M12 socket angled A-coded LED 4-pin to M12 plug straight A-coded 4-pin, POC cable welding-bead resistant orange, suitable for robotic applications, torsion resistant, oil resistant, molecularly cross-linked



Dimensions

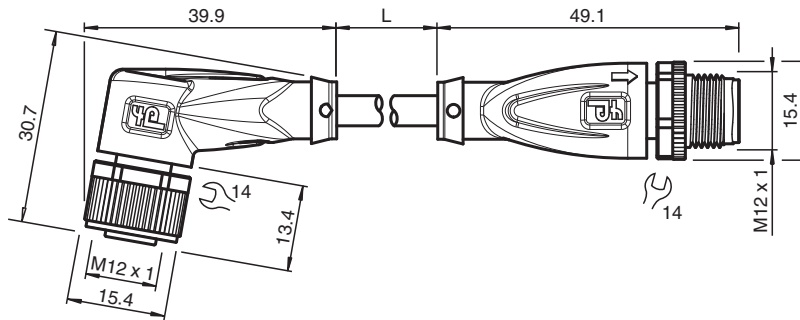

Technical Data

General specifications

| | |
|-----------------------------------|--------------------------|
| Connector 1 | |
| Connection | socket |
| Construction type | M12 |
| Style | angled |
| Locking | screw connection |
| Number of pins | 4 |
| Coding | A-coded |
| Connector 2 | |
| Connection | plug |
| Construction type | M12 |
| Style | straight |
| Locking | screw connection |
| Number of pins | 4 |
| Coding | A-coded |
| Indicators/operating means | |
| LED green | Operating display |
| LED yellow | Functional display pin 4 |
| LED white | Functional display pin 2 |

Release date: 2023-07-13 Date of issue: 2023-07-13 Filename: 228185_eng.pdf

Technical Data

Electrical specifications

| | | |
|-------------------|----------------|----------------------------|
| Operating voltage | U _B | max. 24 V DC -20 % / +25 % |
| Operating current | I _B | max. 4 A |

Conformity

| | | |
|-----------------------|--|--------------------------------------|
| Degree of protection | | EN 60529 |
| Plug connection | | connector M12 x 1 : IEC 61076-2-101 |
| Flammability | | IEC 60332-1-2 , ISO 14572 , ISO 6722 |
| Halogen-free | | IEC 60754-2 |
| Hydrolysis resistance | | ISO 6722 |
| Oil resistance | | ISO 14572 |

Ambient conditions

| | | |
|---------------------|--|---|
| Ambient temperature | | |
| Plug connector | | -40 ... 90 °C (-40 ... 194 °F) |
| Cable, fixed | | -40 ... 120 °C (-40 ... 248 °F) for 20000 h -40 ... 150 °C (-40 ... 302 °F) for 3000 h |
| Cable, flexing | | -15 ... 120 °C (5 ... 248 °F) for 20000 h -15 ... 150 °C (5 ... 302 °F) for 3000 h |
| Pollution degree | | 3 |

Mechanical specifications

| | | |
|------------------------|---|---|
| Plug connector | | |
| Tightening torque | | 0.6 Nm |
| Loosening protection | | available |
| Tool installation | | straight knurling and hexagon nut SW = 14 mm |
| Mating cycles | | min. 100 |
| Degree of protection | | IP68 / IP69 |
| Cable | | according to IEC/EN 60228 (DIN VDE 0295) class 5 |
| Sheath diameter | | 4.8 mm |
| Bending radius | | > 10 x cable diameter, moving > 10 x cable diameter, fixed |
| Sheath stripping force | | max. 50 N / 300 mm |
| Sheath color | | orange (similar to RAL 2003) |
| Number of cores | | 4 |
| Core cross section | | 0.34 mm ² |
| Cores color | | Core 1: brown Core 2: white Core 3: blue Core 4: black |
| Core construction | | 19 x 0.16 mm Ø |
| Length | L | 2 m |
| Cable code | | Li 7Y 41X 4 x 0,34 |
| Drag chain suitability | | |
| Torsion cycles | | min. 300000 |
| Torsional stress | | ± 360 °/30 cm |

Material

| | | |
|------------------|--|-----------------------------|
| PWIS free | | yes |
| Halogen-free | | yes |
| Plug connector | | |
| Screw connection | | Zinc diecast, nickel-plated |
| Body | | TPU, transparent/black |
| Seal | | FKM |
| Contact surface | | gold plated (Au) |
| Flammability | | V-2 |
| Cable | | |
| Sheathing | | POC |
| Core insulation | | ETFE |





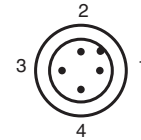
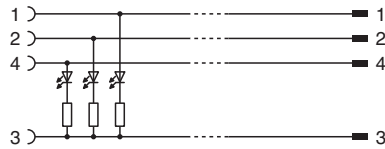
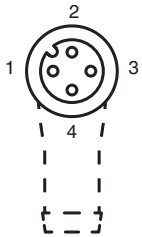

Technical Data

| | |
|--------------------------|-----------------|
| Welding-bead resistance | yes |
| Weld spatter resistance | yes |
| Oil resistance | yes |
| Hydrolysis resistance | yes |
| Flammability | flame-resistant |
| Molecularly cross-linked | yes |

Connection



Accessories

| | | |
|---|------------------------------|--|
|  | MH V1-SCREWDRIVER | Torque screwdriver (0.6 Nm) |
|  | MH V1-BIT M12 | plug-in cap M12 |
|  | V1/V3-LABELHOLDER | Label holder |
|  | V1/V3-LABEL | Label plate |
|  | MH V1-Holder | Modular universal holder for M12 connectors |
|  | V1-CLIP | Unlocking protector for M12 connector |
|  | V1-MARKING-RING-COLOR | Marking rings for M12 connectors, various colors |

Release date: 2023-07-13 Date of issue: 2023-07-13 Filename: 228185_eng.pdf