

# Frequency Converter with Direction and Synchronization Monitor

## KFU8-UFT-2.D

- 2-channel signal conditioner
- Universal usage at different power supplies
- Dry contact or NAMUR inputs
- Input frequency 1 mHz ... 1 kHz
- Current output 0/4 mA ... 20 mA
- Relay contact and transistor output
- Start-up override
- Configurable by PACTware or keypad
- Line fault detection (LFD)



### Function

This signal conditioner analyzes 2 digital signals (NAMUR sensor/mechanical contact) and functions as a rotation direction indicator, slip monitor, frequency monitor or synchronization monitor. Each proximity sensor or switch controls a passive transistor output. The 2 relay outputs indicate if the input signal is above or below the trip value or the rotational direction. The analog output can be programmed to be proportional to the input frequency or slip differential. The unit is easily programmed by the use of a keypad located on the front of the unit or with the PACTware™ configuration software. Line fault detection of the field current is indicated by a red LED. For additional information, refer to the manual and [www.pepperl-fuchs.com](http://www.pepperl-fuchs.com).

### Application

- The device processes 2 input frequencies up to a max. of 1 kHz. The following functions are provided by the device:
- Frequency measurement with freely adjustable trip value monitoring for high and low alarm as well as for frequency current conversion (0/4 mA to 20 mA)
  - Slip monitoring: The slip is calculated from the 2 input frequencies at channel I and II. If the freely parameterisable trip value is exceeded, the respective output switches.
  - Rotation direction signalling: The rotation direction is evaluated from the 2 input signals with the same frequency and a phase shift of 90°. The corresponding outputs switch according to the direction of rotation.
  - The frequency monitoring can be used in combination with rotation direction signalling or slip monitoring.
  - Synchronisation monitor: The synchronisation monitor compares the pulse counts of the 2 inputs. If the measured difference in the pulses is greater than the programmed value the corresponding outputs are switching.
- The 2 electronic outputs serve to repeat the input signals.

### Connection

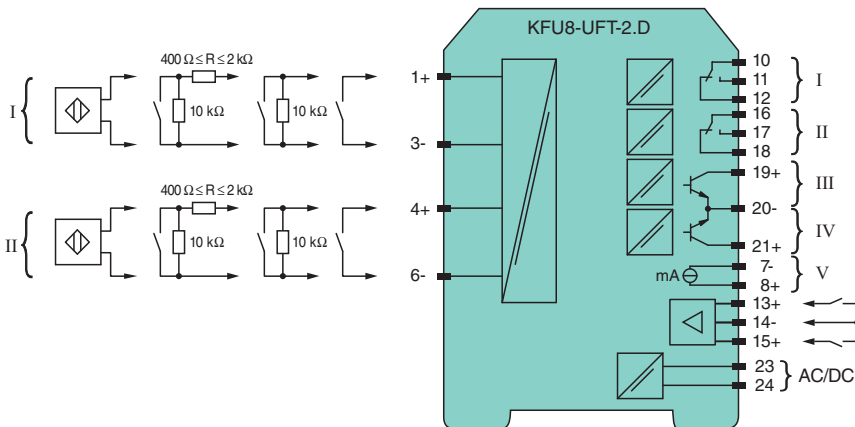

Release date: 2023-05-31 Date of issue: 2023-05-31 Filename: 231201\_eng.pdf

## Technical Data

General specifications		
Signal type		Digital Input
Supply		
Connection		terminals 23, 24
Rated voltage	$U_r$	20 ... 90 V DC / 48 ... 253 V AC 50 ... 60 Hz
Rated current	$I_r$	approx. 130 mA
Power dissipation		2.2 W / 3.5 VA
Power consumption		2.5 W / 4 VA
Interface		
Programming interface		programming socket
Input		
Connection side		field side
Connection		input I: terminals 1+, 3- input II: terminals 4+, 6- input III: terminals 13+, 14- (control input 1) input IV: terminals 15+, 14- (control input 2)
Input I, II		2-wire sensor, sensor acc. to EN 60947-5-6 (NAMUR) or mechanical contact
Open circuit voltage/short-circuit current		8.2 V / 10 mA
Switching point/switching hysteresis		logic 1: > 2.5 mA ; logic 0: < 1.9 mA
Pulse duration		min. 250 $\mu$ s , overlap on direction of rotation signal: $\geq$ 125 $\mu$ s
Input frequency		rotation direction monitoring 0.001 ... 1000 Hz slip monitoring 10 ... 1000 Hz
Line fault detection		breakage $I \leq$ 0.15 mA; short-circuit $I >$ 4 mA
Input III, IV		
Active/Passive		$I >$ 4 mA (for min. 100 ms) / $I <$ 1.5 mA
Open circuit voltage/short-circuit current		18 V / 5 mA
Output		
Connection side		control side
Connection		output I: terminals 10, 11, 12 output II: terminals 16, 17, 18 output III: terminals 19+, 20- output IV: terminals 21+, 20- output V: terminals 7-, 8+
Output I, II		signal, relay
Contact loading		250 V AC / 2 A / $\cos \phi \geq 0.7$ ; 40 DC / 2 A
Mechanical life		$5 \times 10^7$ switching cycles
Energized/De-energized delay		approx. 20 ms / approx. 20 ms
Output III and IV		signal , electronic output, passive
Contact loading		40 V DC
Signal level		1-signal: (L+) -2.5 V (50 mA, short-circuit/overload proof) 0-signal: blocked output (off-state current $\leq$ 10 $\mu$ A)
Output V		analog
Current range		0 ... 20 mA or 4 ... 20 mA
Open loop voltage		max. 24 V DC
Load		max. 650 $\Omega$
Fault signal		downscale $I \leq$ 3.6 mA, upscale $I \geq$ 21.5 mA (acc. NAMUR NE43)
Transfer characteristics		
Input I and II		
Measurement range		0.001 ... 1000 Hz
Resolution		slip monitoring: 1% frequency measurement: 0,1% of measured value; but >0.001Hz
Accuracy		slip monitoring: 1% frequency measurement: 0.5% of measured value; but >0.001Hz
Measuring time		frequency measurement: < 100 ms
Influence of ambient temperature		0.003 %/K (30 ppm)
Output I, II		
Response delay		$\leq$ 200 ms
Output V		
Resolution		< 10 $\mu$ A



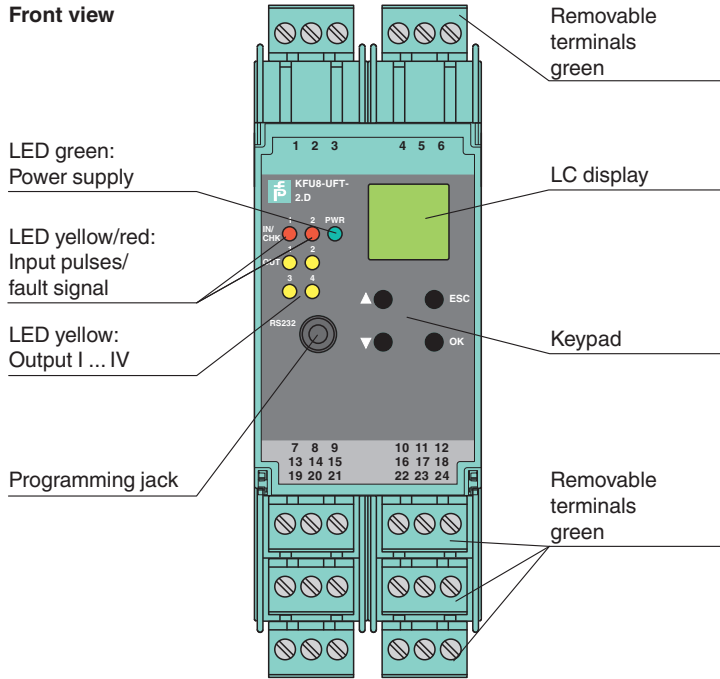

## Technical Data

Accuracy	< 30 $\mu$ A
Influence of ambient temperature	0.005 %/K (50 ppm)
<b>Galvanic isolation</b>	
Input I, II/other circuits	reinforced insulation according to IEC/EN 61010-1, rated insulation voltage 300 V <sub>eff</sub>
Input III, IV/power supply	reinforced insulation according to IEC/EN 61010-1, rated insulation voltage 300 V <sub>eff</sub>
Output I, II/other circuits	reinforced insulation according to IEC/EN 61010-1, rated insulation voltage 300 V <sub>eff</sub>
Mutual output I, II, III	reinforced insulation according to IEC/EN 61010-1, rated insulation voltage 300 V <sub>eff</sub>
Mutual output I, II, IV	reinforced insulation according to IEC/EN 61010-1, rated insulation voltage 300 V <sub>eff</sub>
Output III, IV/power supply	reinforced insulation according to IEC/EN 61010-1, rated insulation voltage 300 V <sub>eff</sub>
Output III, IV/input III, IV	basic insulation according to IEC/EN 61010-1, rated insulation voltage 50 V <sub>eff</sub>
Output III, IV/V	basic insulation according to IEC/EN 61010-1, rated insulation voltage 50 V <sub>eff</sub>
Output V/power supply	reinforced insulation according to IEC/EN 61010-1, rated insulation voltage 300 V <sub>eff</sub>
Interface/power supply	reinforced insulation according to IEC/EN 61010-1, rated insulation voltage 300 V <sub>eff</sub>
Interface/output III, IV	basic insulation according to IEC/EN 61010-1, rated insulation voltage 50 V <sub>eff</sub>
<b>Indicators/settings</b>	
Display elements	LEDs , display
Control elements	Control panel
Configuration	via operating buttons via PACTware
Labeling	space for labeling at the front
<b>Directive conformity</b>	
Electromagnetic compatibility	
Directive 2014/30/EU	EN 61326-1:2013 (industrial locations)
Low voltage	
Directive 2014/35/EU	EN 61010-1:2010
<b>Conformity</b>	
Electromagnetic compatibility	NE 21:2006
Degree of protection	IEC 60529:2001
Input	EN 60947-5-6:2000
<b>Ambient conditions</b>	
Ambient temperature	-20 ... 60 °C (-4 ... 140 °F)
<b>Mechanical specifications</b>	
Degree of protection	IP20
Connection	screw terminals
Mass	300 g
Dimensions	40 x 119 x 115 mm (1.6 x 4.7 x 4.5 inch) (W x H x D) , housing type C2
Mounting	on 35 mm DIN mounting rail acc. to EN 60715:2001
<b>General information</b>	
Supplementary information	Observe the certificates, declarations of conformity, instruction manuals, and manuals where applicable. For information see <a href="http://www.pepperl-fuchs.com">www.pepperl-fuchs.com</a> .





## Assembly



## Matching System Components

	<b>DTM Interface Technology</b>	Device type manager (DTM) for interface technology
	<b>PACTware 5.0</b>	FDT Framework
	<b>K-ADP-USB</b>	Programming adapter with USB interface
	<b>K-DUCT-GY</b>	Profile rail, wiring comb field side, gray

## Accessories

	<b>K-250R</b>	Measuring resistor
	<b>K-500R0%1</b>	Measuring resistor
	<b>KF-ST-5GN</b>	Terminal block for KF modules, 3-pin screw terminal, green
	<b>KF-CP</b>	Red coding pins, packaging unit: 20 x 6

Release date: 2023-05-31 Date of issue: 2023-05-31 Filename: 231201\_eng.pdf

**Characteristic Curve**

**Maximum Switching Power of Output Contacts**

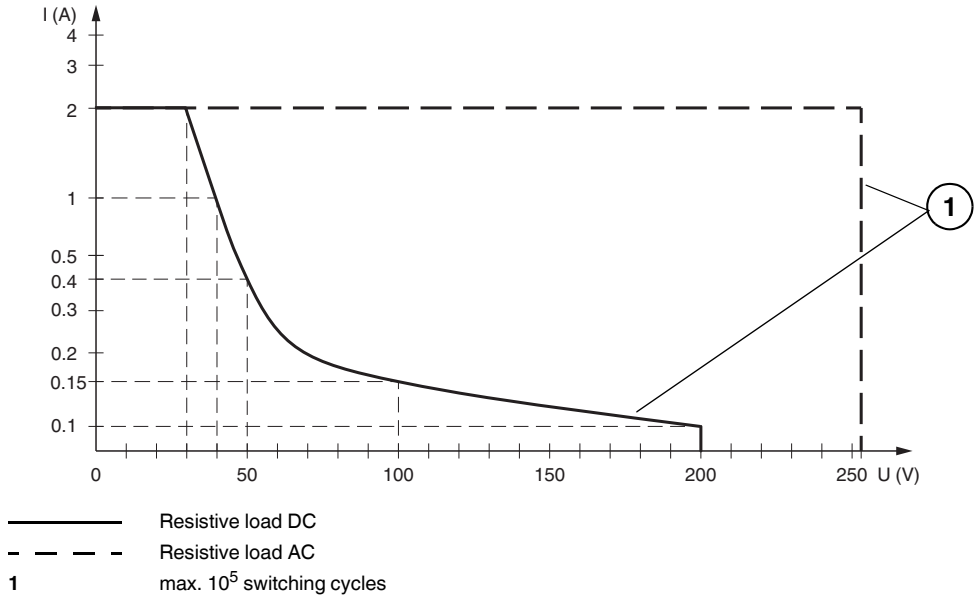

Release date: 2023-05-31 Date of issue: 2023-05-31 Filename: 231201\_eng.pdf