



# Temperature Converter with Trip Values

## KFU8-GUT-Ex1.D

- 1-channel isolated barrier
- Universal usage at different power supplies
- Thermocouple, RTD, potentiometer or voltage input
- Redundant TC input
- Current output 0/4 mA ... 20 mA
- 2 relay contact outputs
- Configurable by PACTware or keypad
- Line fault (LFD) and sensor burnout detection
- Up to SIL 2 acc. to IEC/EN 61508 / IEC/EN 61511



### Function

This isolated barrier is used for intrinsic safety applications. The device converts the signal of a resistance thermometer, thermocouple, potentiometer, or voltage source to a proportional output current. It also provides a relay trip value. The removable terminal block K-CJC-\*\* is available as an accessory for internal cold junction compensation of thermocouples. A fault is signalized by LEDs acc. to NAMUR NE44. The device is easily configured by the use of the PACTware configuration software. For additional information, refer to the manual and [www.pepperl-fuchs.com](http://www.pepperl-fuchs.com).

### Connection

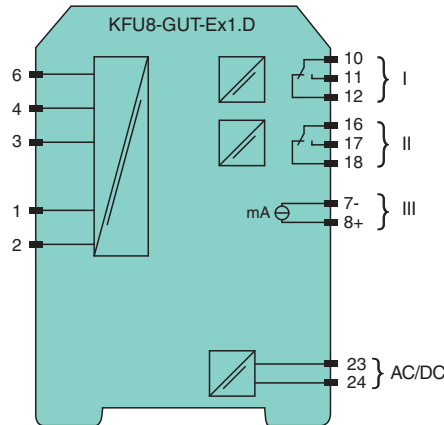
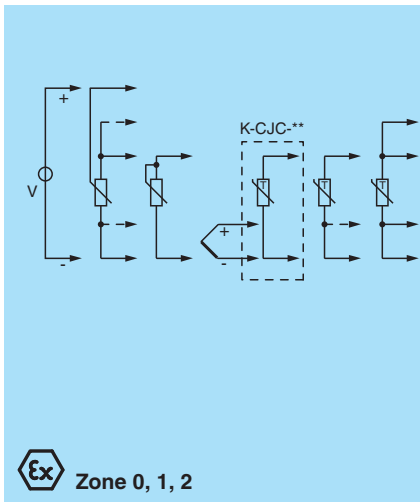

### Technical Data

General specifications	
Signal type	Analog input
Functional safety related parameters	
Safety Integrity Level (SIL)	SIL 2
Supply	
Connection	terminals 23, 24
Rated voltage	$U_r$ 20 ... 90 V DC / 48 ... 253 V AC
Power dissipation/power consumption	$\leq 2$ W ; 2.5 VA / 2.2 W ; 3 VA
Interface	

Release date: 2023-01-03 Date of issue: 2023-01-03 Filename: 231229\_eng.pdf

## Technical Data

Programming interface	programming socket
<b>Input</b>	
Connection side	field side
Connection	terminals 1, 2, 3, 4, 6
<b>RTD</b>	
Types of measuring	Pt100, Pt500, Pt1000, Ni100, Ni1000
Lead resistance	2-, 3-, 4-wire technology
Measurement loop monitoring	max. 50 $\Omega$
Measurement loop monitoring	sensor breakage, sensor short-circuit
<b>Thermocouples</b>	
Cold junction compensation	type B, E, J, K, L, N, R, S, T (IEC 584-1: 1995)
Measurement loop monitoring	external and internal
Measurement loop monitoring	sensor breakage
<b>Potentiometer</b>	
Types of measuring	0.8 ... 20 k $\Omega$
Types of measuring	2-, 3-, 5-wire technology
Voltage	0 ... 10 V , 2 ... 10 V , 0 ... 1 V , -100 ... 100 mV
Input resistance	$\geq$ 250 k $\Omega$ (0 ... 10 V) min. 1 M $\Omega$ (0 ... 1 V, -100 ... 100 mV)
Measuring current	approx. 400 $\mu$ A with resistance measuring sensor
<b>Output</b>	
Connection side	control side
Connection	output I: terminals 10, 11, 12 output II: terminals 16, 17, 18 output III: terminals 8+, 7-
<b>Output I, II</b>	
Contact loading	relay
Mechanical life	250 V AC / 2 A / $\cos \phi \geq 0.7$ ; 40 DC / 2 A
Energized/De-energized delay	5 x 10 <sup>7</sup> switching cycles
Energized/De-energized delay	approx. 20 ms / approx. 20 ms
<b>Output III</b>	
Current range	Analog current output
Open loop voltage	0 ... 20 mA or 4 ... 20 mA
Load	max. 24 V DC
Fault signal	max. 650 $\Omega$
Fault signal	downscale I $\leq$ 3.6 mA, upscale I $\geq$ 21 mA (acc. NAMUR NE43)
<b>Transfer characteristics</b>	
Deviation	
Temperature effect	Input: 0.005 %/K (50 ppm) of span ; current output: 0.005 %/K (50 ppm) of span
RTD	max. 0.2 % of span
Thermocouples	max. 10 $\mu$ V deviation of CJC: $\pm$ 0.8 K
Voltage	0.1 % of span
Potentiometer	0.1 % of span when $<$ 5 k $\Omega$ 0.5 % of span when $>$ 5 k $\Omega$
Current output	max. 20 $\mu$ A
Sampling rate	approx. 700 ms
<b>Galvanic isolation</b>	
Input/Other circuits	reinforced insulation according to IEC/EN 61010-1, rated insulation voltage 300 V <sub>eff</sub>
Output I, II against eachother	reinforced insulation according to IEC/EN 61010-1, rated insulation voltage 300 V <sub>eff</sub>
Output I, II/other circuits	reinforced insulation according to IEC/EN 61010-1, rated insulation voltage 300 V <sub>eff</sub>
Output III/power supply	reinforced insulation according to IEC/EN 61010-1, rated insulation voltage 300 V <sub>eff</sub>
Interface/power supply	reinforced insulation according to IEC/EN 61010-1, rated insulation voltage 300 V <sub>eff</sub>
<b>Indicators/settings</b>	
Display elements	LEDs , display
Control elements	Control panel
Configuration	via operating buttons via PACTware
Labeling	space for labeling at the front
<b>Directive conformity</b>	



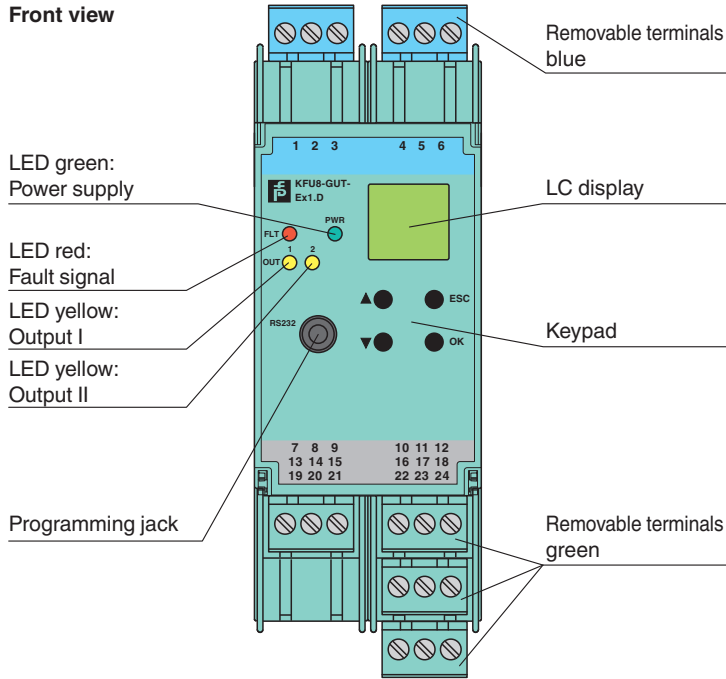

## Technical Data

Electromagnetic compatibility		
Directive 2014/30/EU		EN 61326-1:2013 (industrial locations)
Low voltage		
Directive 2014/35/EU		EN 61010-1:2010
<b>Conformity</b>		
Electromagnetic compatibility		NE 21:2007
Degree of protection		IEC 60529:2001
<b>Ambient conditions</b>		
Ambient temperature		-20 ... 60 °C (-4 ... 140 °F)
<b>Mechanical specifications</b>		
Degree of protection		IP20
Connection		screw terminals
Mass		300 g
Dimensions		40 x 119 x 115 mm (1.6 x 4.7 x 4.5 inch) (W x H x D) , housing type C2
Mounting		on 35 mm DIN mounting rail acc. to EN 60715:2001
<b>Data for application in connection with hazardous areas</b>		
EU-type examination certificate		TÜV 03 ATEX 2140
Marking		Ⓜ II (1)G [Ex ia Ga] IIC Ⓜ II (1)D [Ex ia Da] IIIC Ⓜ I (M1) [Ex ia Ma] I
Input		Ex ia
Supply		
Maximum safe voltage	$U_m$	40 V DC (Attention! The rated voltage can be lower.)
Input		
terminals 2, 6 (for active equipment)		
Voltage	$U_o$	13.1 V
Current	$I_o$	8 mA
Power	$P_o$	67 mW
Voltage	$U_i$	29 V
Current	$I_i$	11 mA
Power	$P_i$	200 mW
Inputs		
terminals 1, 2, 3, 4, 6 (for passive equipment)		
Voltage $U_o$		13.1 V
Current $I_o$		21 mA
Power $P_o$		67 mW
Analog output		
Maximum safe voltage	$U_m$	40 V (Attention! The rated voltage can be lower.)
Interface		
Maximum safe voltage	$U_m$	40 V (Attention! The rated voltage can be lower.) , RS 232
Galvanic isolation		
Input/Other circuits		safe electrical isolation acc. to IEC/EN 60079-11, voltage peak value 375 V
Directive conformity		
Directive 2014/34/EU		EN IEC 60079-0:2018+AC:2020 , EN 60079-11:2012
<b>International approvals</b>		
IECEx approval		
IECEx certificate		IECEx TUN 09.0019
IECEx marking		[Ex ia Ga] IIC , [Ex ia Da] IIIC , [Ex ia Ma] I
<b>General information</b>		
Supplementary information		Observe the certificates, declarations of conformity, instruction manuals, and manuals where applicable. For information see <a href="http://www.pepperl-fuchs.com">www.pepperl-fuchs.com</a> .







## Assembly



## Matching System Components

	<b>DTM Interface Technology</b>	Device type manager (DTM) for interface technology
	<b>PACTware 5.0</b>	FDT Framework
	<b>K-ADP-USB</b>	Programming adapter with USB interface
	<b>K-DUCT-BU</b>	Profile rail, wiring comb field side, blue

## Accessories

	<b>K-250R</b>	Measuring resistor
	<b>K-500R0%1</b>	Measuring resistor
	<b>K-CJC-BU</b>	Terminal block for cold junction compensation, 3-pin screw terminal, blue
	<b>KF-ST-5GN</b>	Terminal block for KF modules, 3-pin screw terminal, green
	<b>KF-ST-5BU</b>	Terminal block for KF modules, 3-pin screw terminal, blue
	<b>KF-CP</b>	Red coding pins, packaging unit: 20 x 6

Release date: 2023-01-03 Date of issue: 2023-01-03 Filename: 231229\_eng.pdf

**Application**

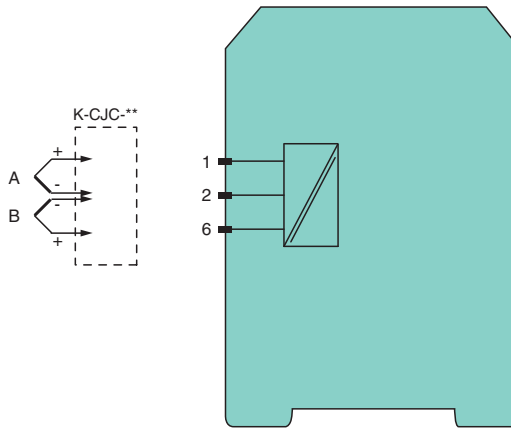

**Redundant thermocouple**

For higher availability it is possible to connect a second redundant thermocouple (B) of the same type to the temperature converter. The cold junction temperature is taken from the connected terminal block.

If the deviation of the both thermocouples (A and B) exceed the selected tolerance, an error will occur. If a lead breakage of one thermocouple (e. g. A) has been detected, an error message occurs and the value of the second thermocouple (B) will be taken for further calculation.

Release date: 2023-01-03 Date of issue: 2023-01-03 Filename: 231229\_eng.pdf