

Female cordset

V3-WM-OR5M-POC

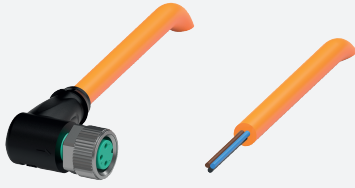

- Welding-bead resistant
- Suitable for robotic applications / torsion resistant
- Degree of protection IP68
- Free of paint wetting interfering substances
- Ozone resistant
- Hydrolysis resistant
- Oil resistant
- Halogen-free
- Specific design protects against loosening and inaccurate installation

Female cordset single-ended M8 angled A-coded, 3-pin, POC cable welding-bead resistant orange, suitable for robotic applications, torsion resistant, oil resistant, molecularly cross-linked



Dimensions

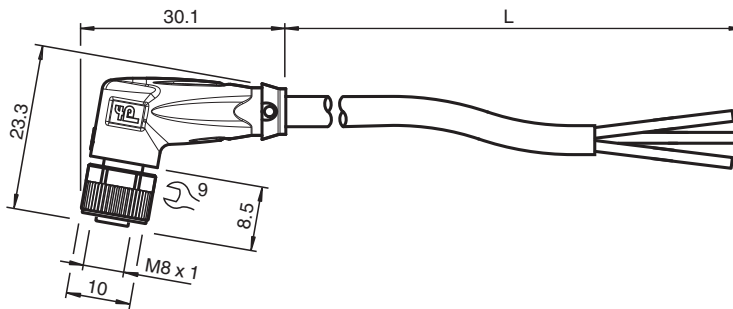

Technical Data

General specifications			
Connector 1			
Connection		socket	
Construction type		M8	
Style		angled	
Locking		screw connection	
Number of pins		3	
Coding		A-coded	
Electrical specifications			
Operating voltage	U_B	max. 48 V AC / 60 V DC	
Operating current	I_B	max. 3 A	
Conformity			
Degree of protection		EN 60529	
Plug connection		connector M8 x 1 : IEC 61076-2-104	
Flammability		IEC 60332-1-2 , ISO 14572 , ISO 6722	
Halogen-free		IEC 60754-2	
Hydrolysis resistance		ISO 6722	
Oil resistance		ISO 14572	
Ambient conditions			
Ambient temperature			
Plug connector		-40 ... 90 °C (-40 ... 194 °F)	

Release date: 2023-09-04 Date of issue: 2023-09-04 Filename: 231528_eng.pdf



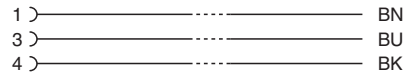

Technical Data

Cable, fixed		-40 ... 120 °C (-40 ... 248 °F) for 20000 h -40 ... 150 °C (-40 ... 302 °F) for 3000 h
Cable, flexing		-15 ... 120 °C (5 ... 248 °F) for 20000 h -15 ... 150 °C (5 ... 302 °F) for 3000 h
Pollution degree		3
Mechanical specifications		
Plug connector		
Tightening torque		0.4 Nm
Loosening protection		available
Tool installation		straight knurling and hexagon nut SW = 9 mm
Mating cycles		min. 100
Degree of protection		IP68
Cable		
Sheath diameter		4.8 mm
Bending radius		> 10 x cable diameter, moving > 10 x cable diameter, fixed
Sheath stripping force		max. 50 N / 300 mm
Sheath color		orange (similar to RAL 2003)
Number of cores		4
Core cross section		0.34 mm ²
Cores color		Core 1: brown Core 2: not used Core 3: blue Core 4: black
Core construction		19 x 0.16 mm Ø
Length	L	5 m
Cable code		Li 7Y 41X 4 x 0,34
Drag chain suitability		
Torsion cycles		min. 300000
Torsional stress		± 360 °/ 30 cm
Material		
PWIS free		yes
Halogen-free		yes
Plug connector		
Screw connection		Zinc diecast, nickel-plated
Body		TPU, black
Seal		FKM
Contact surface		gold plated (Au)
Flammability		V-2
Cable		
Sheathing		POC
Core insulation		ETFE
Welding-bead resistance		yes
Weld spatter resistance		yes
Oil resistance		yes
Hydrolysis resistance		yes
Flammability		flame-resistant
Molecularly cross-linked		yes

Connection



Accessories

	MH V3-SCREWDRIVER	Torque screwdriver (0.4 Nm)
	MH V3-BIT M8	plug-in cap for M8
	MH V3-Holder	Modular universal holder for M8 connectors
	V1/V3-LABELHOLDER	Label holder
	V1/V3-LABEL	Label plate