

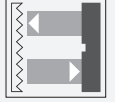

Retroreflective sensor RLK29-55-5060



- Robust, compact photoelectric sensor for single-beam gate protection
- High detection ranges achievable
- 2500 V Proof voltage between the relay connection terminals and the device electronics
- Not sensitive to ambient light, even with energy saving lamps
- Version with accessories in scope of delivery

Robust, compact, long range photoelectric sensors for detecting people, objects and vehicles



Function

Series 29 is a range of low-cost and, most importantly, reliable photoelectric sensors for monitoring industrial doors, elevators, and automatic gates. Their high degree of protection makes them the ideal solution for tasks outdoors and at thresholds, and in harsh environments. These "universal-voltage sensors" can be operated with any supply voltage from 24 V to 240 V, and with direct current or alternating current.

Application

- Monitoring closing edges of automatic industrial doors and elevators
- Monitoring the swing range of automatic gates
- Detecting and tracking objects in material handling

Dimensions

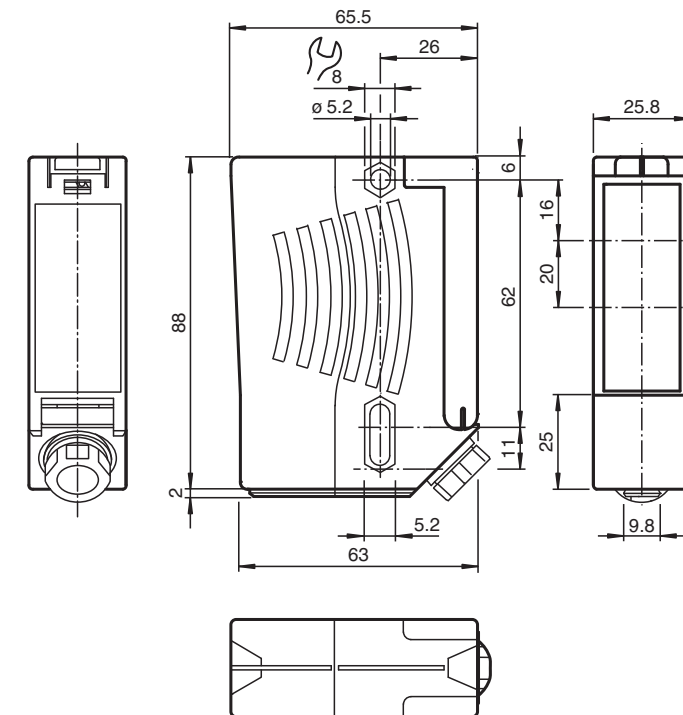

Technical Data

General specifications

Effective detection range	0 ... 12 m
Reflector distance	0.04 ... 12 m
Threshold detection range	14 m
Reference target	reflector C110-2 Diameter: 84 mm , included with delivery
Light source	LED
Light type	modulated visible red light , 640 nm
Diameter of the light spot	approx. 35 mm at a distance of 12 m
Opening angle	$\pm 1^\circ$
Ambient light limit	90000 Lux

Functional safety related parameters

MTTF _d	1460 a
Mission Time (T _M)	20 a
Diagnostic Coverage (DC)	0 %

Indicators/operating means

Function indicator	LED red illuminates: when beam is free flashes: when level falls below function reserve off: when beam is interrupted
--------------------	--

Electrical specifications

Operating voltage	U _B	24 ... 230 V AC/DC
Ripple		10 %
No-load supply current	I ₀	≤ 8.5 mA

Technical Data

Power consumption	P ₀	0.2 W at 24 V DC , 1.8 W at 230 V AC 3 VA
Output		
Switching type		light-on
Signal output		Relay, 1 alternator
Switching voltage		230 V AC
Switching current		max. 2 A
Switching frequency	f	7 Hz
Response time		50 ms
Conformity		
Product standard		EN 60947-5-2
Approvals and certificates		
CE conformity		yes
UL approval		cULus Listed Caution: This equipment is considered as open-type equipment. It must be mounted within an enclosure, that is suitably designed for protection against internal fire and personal injury resulting from accessibility to live parts according UL 508.
CCC approval		Certified by China Compulsory Certification (CCC)
Ambient conditions		
Ambient temperature		-20 ... 60 °C (-4 ... 140 °F)
Storage temperature		-20 ... 60 °C (-4 ... 140 °F)
Mechanical specifications		
Degree of protection		IP67
Connection		terminal compartment
Material		
Housing		Plastic ABS, flame resistant
Optical face		plastic
Mass		approx. 200 g
Note		Safety fuse ≤ 2 A (slow-blow) according to IEC 60127-2 Sheet 1 Recommendation: after a short circuit, check that the device is functioning correctly.

Connection Assignment

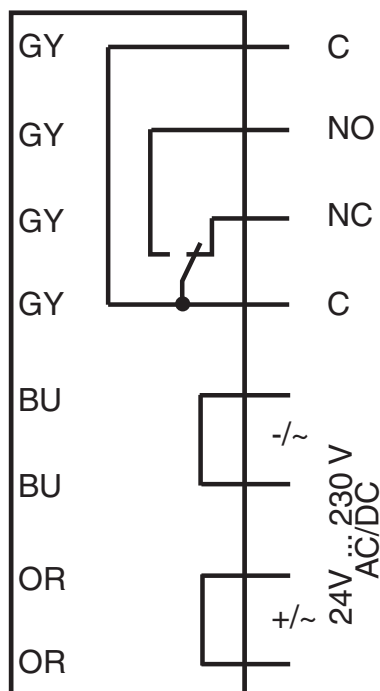

Release date: 2023-04-04 Date of issue: 2023-04-04 Filename: 232252_eng.pdf

Assembly

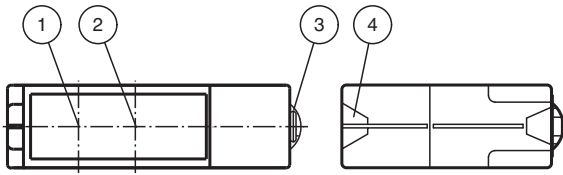





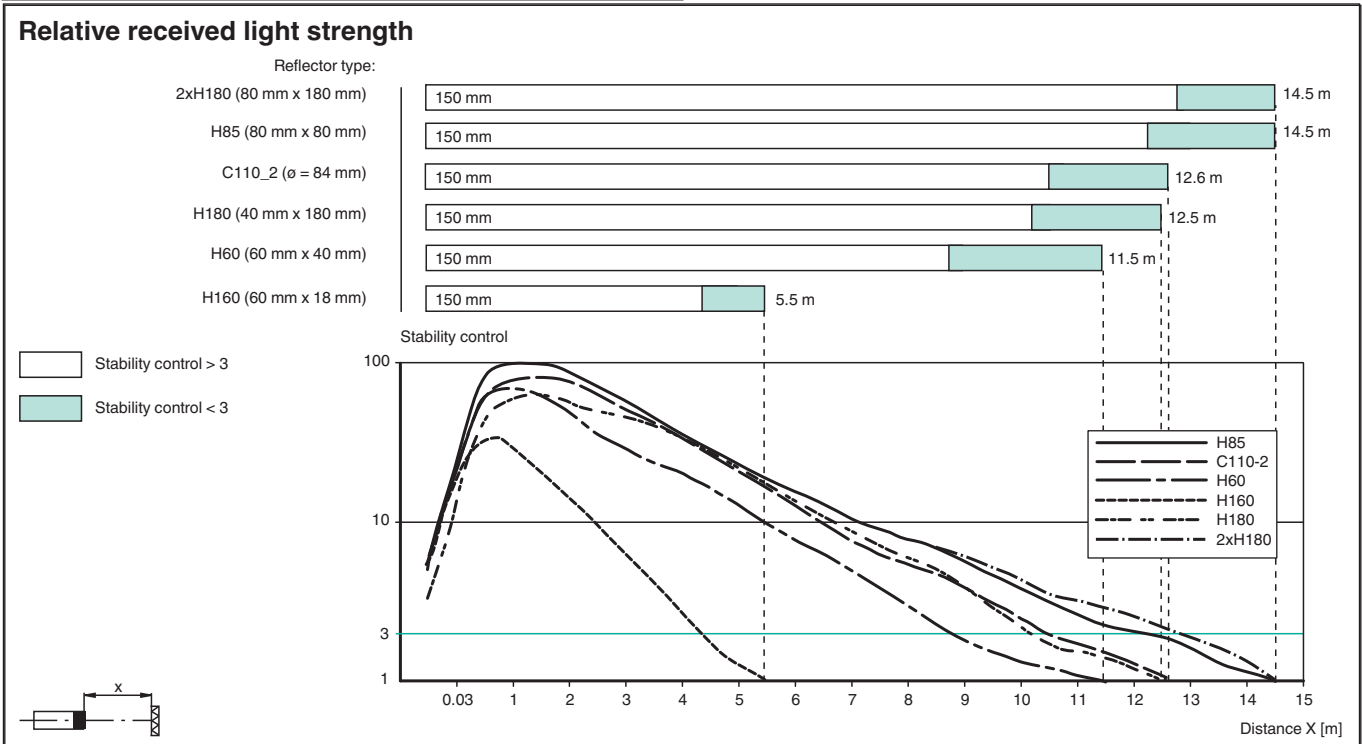
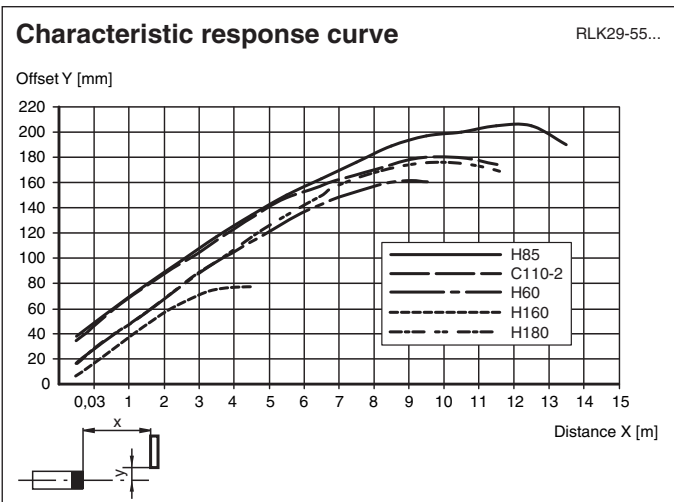





1	Emitter	
2	Receiver	
3	Dovetail mount	
4	Functional display	red

Characteristic Curve



Release date: 2023-04-04 Date of issue: 2023-04-04 Filename: 232252_eng.pdf

Accessories

	OMH-RLK29	Mounting bracket
	OMH-RLK29-HW	Mounting bracket for rear wall mounting
	OMH-RLK29-HW-120	Mounting bracket for rear wall mounting
	OMH-21	Mounting bracket: mounting aid for sensors in the RL* series
	OFR-100/100	Reflective tape 100 mm x 100 mm
	REF-C110-2	Reflector, round ø 84 mm, central mounting hole
	REF-H180	Reflector, rectangular 182 mm x 42 mm, mounting holes
	REF-H160	Reflector, rectangular 60 mm x 18 mm, mounting holes
	REF-H85-2	Reflector, rectangular 84.5 mm x 84.5 mm, mounting holes
	REF-H60-2	Reflector with mounting holes
	REF-H50	Reflector, rectangular 51 mm x 61 mm, mounting holes, fixing strap