



## Distance sensor

VDM28-50-R1-IO/73c/110/122



- Retroreflective laser distance sensor
- Measuring method PRT (Pulse Ranging Technology)
- Accurate, clear, and reproducible measuring results
- Red laser as the light emitter
- Version with laser class 1
- Version with IO-Link interface
- Version with analog output

Universal distance sensor, measurement to reflector, IO-Link interface, measuring method PRT, 50 m detection range, red laser light, laser class 1, push-pull output, analog output, M12 plug



IO-Link

### Function

The VDM28 distance measurement device employs Pulse Ranging Technology (PRT). It has a repeat accuracy of 5 mm with an operating range of 0.2 ... 50 m and an absolute accuracy of 25 mm. The compact housing of the Series 28 photoelectric sensors, with dimensions of 88 mm (height), 26 mm (width) and 54 mm (depth), make it the smallest device available in its class.

### Application

- Object identification or object classification
- Positioning
- Level measurement
- Collision avoidance/distance measurement
- Compartment occupied checks
- Rack fine positioning
- Stack height control
- Coil measurement
- Dip monitoring
- Lift height checks
- Opening impulse sensor and closing edge monitoring on automatic doors, industrial gates, and barrier systems
- Vehicle detection for traffic engineering purposes (e. g., monitoring of individual parking spaces)
- Height measurement in tunnels and entranceways
- Anti-collision protection on automated transport systems

## Dimensions

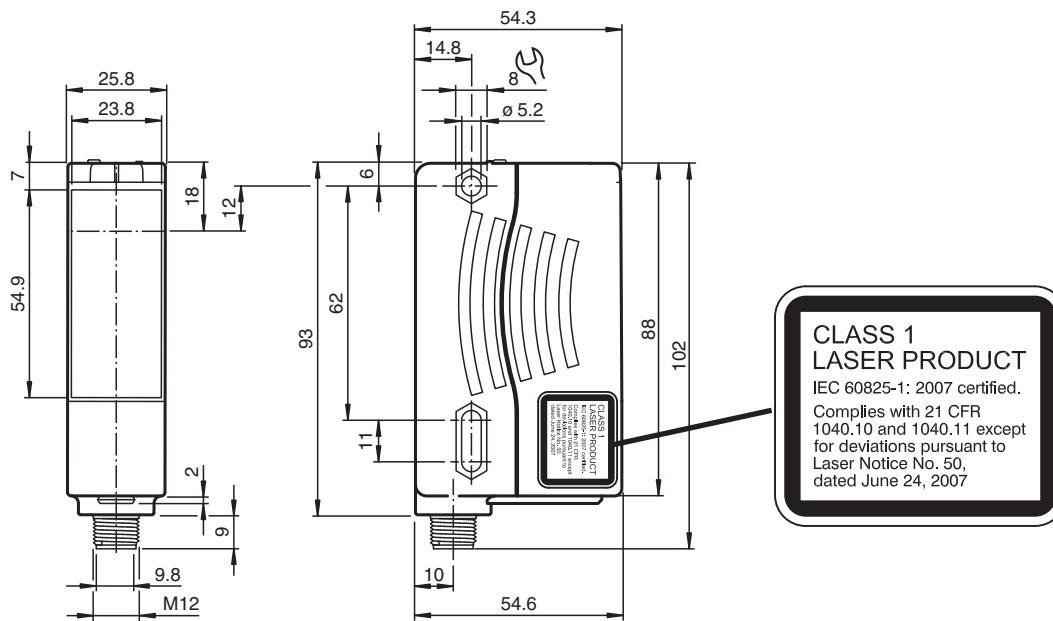

## Technical Data

### General specifications

Measuring range	0.2 ... 50 m
Reference target	OFR-100/100
Light source	laser diode typ. service life 85,000 h at Ta = +25 °C
Light type	modulated visible red light
Laser nominal ratings	
Note	LASER LIGHT , DO NOT STARE INTO BEAM
Laser class	1
Wave length	660 nm
Beam divergence	< 1.5 mrad
Pulse length	approx. 4 ns
Repetition rate	250 kHz
max. pulse energy	< 1.5 nJ
Angle deviation	max. ± 2°
Measuring method	Pulse Ranging Technology (PRT)
Diameter of the light spot	< 50 mm at a distance of 50 m at 20 °C
Ambient light limit	50000 Lux

### Functional safety related parameters

MTTF <sub>d</sub>	200 a
Mission Time (T <sub>M</sub> )	10 a
Diagnostic Coverage (DC)	0 %

### Indicators/operating means

Operation indicator	LED green
Function indicator	2 LEDs yellow for switching state
Teach-in indicator	Teach-In: LED green/yellow equiphase flashing; 2.5 Hz Teach Error: LED green/yellow non equiphase flashing; 8.0 Hz
Control elements	5-step rotary switch for operating modes selection (threshold setting and operating modes)
Control elements	Switch for setting the threshold values

## Technical Data

Electrical specifications		
Operating voltage	$U_B$	10 ... 30 V DC / when operating in IO-Link mode: 18 ... 30 V
Ripple		10 % within the supply tolerance
No-load supply current	$I_0$	≤ 70 mA / 24 V DC
Time delay before availability	$t_v$	< 1.5 s at 20 °C
Interface		
Interface type		IO-Link
Protocol		IO-Link V1.0
Cycle time		min. 2.3 ms
Mode		COM2 (38.4 kBit/s)
Process data width		16 bit
SIO mode support		yes
Output		
Signal output		Push-pull output, short-circuit protected, reverse polarity protected
Switching voltage		max. 30 V DC
Switching current		max. 100 mA
Measurement output		1 analog output 4 ... 20 mA, short-circuit/overload protected
Switching frequency	$f$	50 Hz
Response time		10 ms
Conformity		
Electromagnetic compatibility		EN 61000-6-2, EN 61000-6-4
Laser safety		IEC 60825-1:2014
Measurement accuracy		
Absolute accuracy		± 25 mm
Repeat accuracy		< 5 mm
Approvals and certificates		
Protection class		III
UL approval		cULus Listed, Class 2 Power Source, Type 1 enclosure
CCC approval		CCC approval / marking not required for products rated ≤36 V
FDA approval		IEC 60825-1:2014 Complies with 21 CFR 1040.10 and 1040.11 except for conformance with IEC 60825-1 Ed. 3 as described in Laser Notice 56, dated May 8, 2019.
Ambient conditions		
Ambient temperature		-30 ... 55 °C (-22 ... 131 °F)
Storage temperature		-30 ... 70 °C (-22 ... 158 °F)
Mechanical specifications		
Degree of protection		IP67
Connection		4-pin, M12 x 1 connector
Material		
Housing		plastic
Optical face		PMMA
Mass		90 g
Dimensions		
Height		88 mm
Width		25.8 mm
Depth		54.6 mm

**Connection Assignment**

Option:

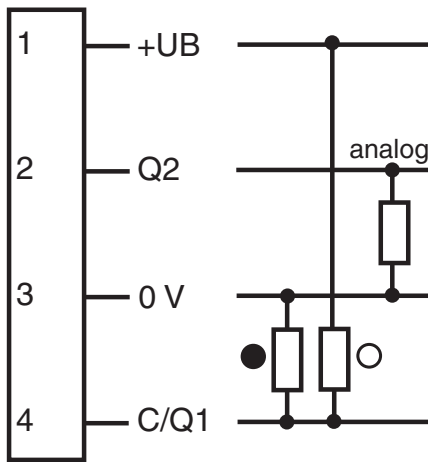

- = Light on
- = Dark on

**Connection Assignment**

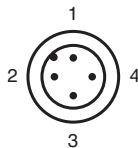

Wire colors in accordance with EN 60947-5-2

- 1 | BN (brown)
- 2 | WH (white)
- 3 | BU (blue)
- 4 | BK (black)

**Assembly**

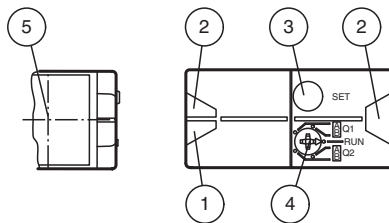

1	Operating display	green
2	Signal display	yellow
3	TEACH-IN button	
4	Mode rotary switch	
5	Laser output	

Release date: 2025-02-28 Date of issue: 2025-02-28 Filename: 232767\_eng.pdf

## Application



Release date: 2025-02-28 Date of issue: 2025-02-28 Filename: 232767\_eng.pdf

**Teach-In**

You can use the rotary switch to select the relevant switching threshold A and/or B for teaching in for switching output **Q1**. The yellow LEDs indicate the current state of the selected output.

To store a switching threshold (distance measured value), press and hold the "SET" button until the yellow and green LEDs flash in phase (approx. 2 s). Teach-In starts when the "SET" button is released.

Successful Teach-In is indicated by alternating flashing (2.5 Hz) of the yellow and green LEDs.

An unsuccessful Teach-In is indicated by rapidly alternating flashing (8 Hz) of the yellow and green LEDs.

After an unsuccessful Teach-In, the sensor continues to operate with the previous valid setting after the relevant visual fault signal is issued.

Different switching modes can be defined by teaching in the relevant distance measured values for the switching thresholds A and B:

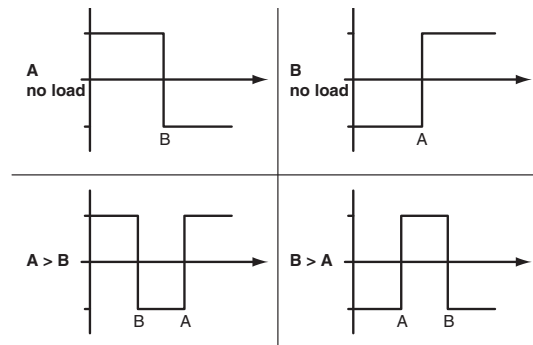

Every taught-in switching threshold can be rethought (overwritten) by pressing the SET button again.

Pressing and holding the "SET" button for > 5 s completely deletes the taught-in value. The yellow and green LEDs go out simultaneously to indicate that this procedure has been completed.

Minimum and maximum values for the analog output **Q2** are taught in in the same way as those for the switching output:

The following values apply: A = 4 mA  
B = 20 mA

This provides three different options for operation:

**A < B -> rising slope**

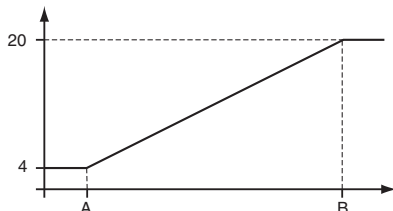

**A > B -> falling slope**

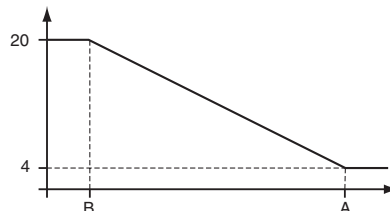

**A empty -> zero start point**

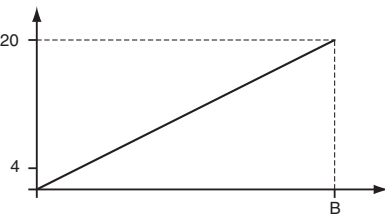

**Reset to default settings:**

Factory setting for switching output Q1:

- Switching output inactive

Factory setting for analog output Q2:

A = 200 mm

B = 5000 mm



Value B cannot be deleted

The "zero start point" operating mode can be obtained by deleting value A

- Set the rotary switch to the "RUN" position
- Press and hold the "SET" button until the yellow and green LEDs stop flashing in phase (approx. 10 s)
- When the green LED lights up continuously, the procedure is complete.

**Error messages:**

- Short circuit: In the event of a short circuit at the sensor output, the green LED flashes with a frequency of approx. 4 Hz.

Release date: 2025-02-28 Date of issue: 2025-02-28 Filename: 232767\_eng.pdf

- Teach error: In the event of a teach error, the yellow and green LEDs flash alternately with a frequency of approx. 8 Hz.

**Note!**

The difference in the taught-in distance measured values for switching thresholds A and B must be greater than 20 mm.

If the difference in the taught-in measured values is the same as or smaller than the set switching hysteresis, the sensor will visually signal an unsuccessful Teach-In. The last distance measured value that was taught in will not be adopted by the sensor.

Select a new distance measured value for switching threshold A or B with a greater difference between the switching thresholds.

Teach in this distance measured value on the sensor again.

Switching threshold A can be deleted or set to a value of zero.  
(E.g., when setting the "zero start point" curve).

However, switching threshold B can neither be deleted nor set to a value of zero.