

# Female cordset

## V1-W-E8W-OR5M-POC

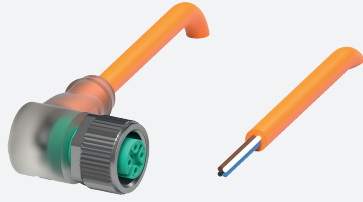

- Built-in LED, as operating and function indicator
- Welding-bead resistant
- Suitable for robotic applications / torsion resistant
- Degree of protection IP68 / IP69
- Free of paint wetting interfering substances
- Ozone resistant
- Hydrolysis resistant
- Oil resistant
- Halogen-free
- Specific design protects against loosening and inaccurate installation

Female cordset single-ended M12 angled A-coded, LED 4-pin, POC cable welding-bead resistant orange, suitable for robotic applications, torsion resistant, oil resistant, molecularly cross-linked



### Dimensions

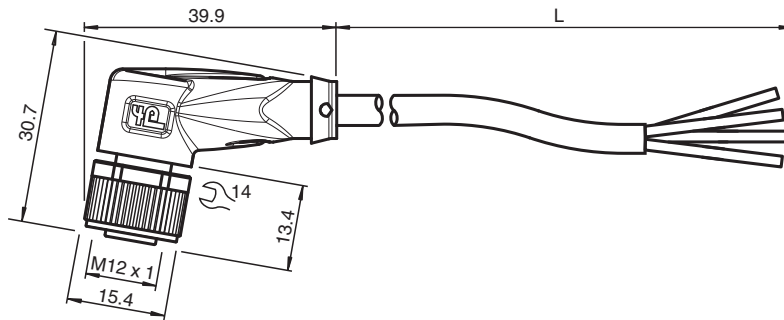

### Technical Data

| General specifications            |       |                            |  |
|-----------------------------------|-------|----------------------------|--|
| <b>Connector 1</b>                |       |                            |  |
| Connection                        |       | socket                     |  |
| Construction type                 |       | M12                        |  |
| Style                             |       | angled                     |  |
| Locking                           |       | screw connection           |  |
| Number of pins                    |       | 4                          |  |
| Coding                            |       | A-coded                    |  |
| <b>Connector 2</b>                |       |                            |  |
| Connection                        |       | cable end                  |  |
| <b>Indicators/operating means</b> |       |                            |  |
| LED green                         |       | Operating display          |  |
| LED yellow                        |       | Functional display pin 4   |  |
| LED white                         |       | Functional display pin 2   |  |
| <b>Electrical specifications</b>  |       |                            |  |
| Operating voltage                 | $U_B$ | max. 24 V DC -20 % / +25 % |  |
| Operating current                 | $I_B$ | max. 4 A                   |  |
| <b>Conformity</b>                 |       |                            |  |
| Degree of protection              |       | EN 60529                   |  |

Release date: 2023-08-23 Date of issue: 2023-08-23 Filename: 233462\_eng.pdf

## Technical Data

|                                  |   |   |
|----------------------------------|---|---|
| Plug connection                  |   | connector M12 x 1 : IEC 61076-2-101   |
| Flammability                     |   | IEC 60332-1-2 , ISO 14572 , ISO 6722  |
| Halogen-free                     |   | IEC 60754-2   |
| Hydrolysis resistance            |   | ISO 6722  |
| Oil resistance                   |   | ISO 14572   |
| <b>Ambient conditions</b>        |   |   |
| Ambient temperature              |   |   |
| Plug connector                   |   | -40 ... 90 °C (-40 ... 194 °F)  |
| Cable, fixed                     |   | -40 ... 120 °C (-40 ... 248 °F) for 20000 h<br>-40 ... 150 °C (-40 ... 302 °F) for 3000 h |
| Cable, flexing                   |   | -15 ... 120 °C (5 ... 248 °F) for 20000 h<br>-15 ... 150 °C (5 ... 302 °F) for 3000 h     |
| Pollution degree                 |   | 3   |
| <b>Mechanical specifications</b> |   |   |
| Plug connector                   |   |   |
| Tightening torque                |   | 0.6 Nm  |
| Loosening protection             |   | available   |
| Tool installation                |   | straight knurling and hexagon nut SW = 14 mm  |
| Mating cycles                    |   | min. 100  |
| Degree of protection             |   | IP68 / IP69   |
| Cable                            |   |   |
| Sheath diameter                  |   | 4.8 mm  |
| Bending radius                   |   | > 10 x cable diameter, moving<br>> 10 x cable diameter, fixed                             |
| Sheath stripping force           |   | max. 50 N / 300 mm  |
| Sheath color                     |   | orange (similar to RAL 2003)  |
| Number of cores                  |   | 4   |
| Core cross section               |   | 0.34 mm <sup>2</sup>  |
| Cores color                      |   | Core 1: brown<br>Core 2: white<br>Core 3: blue<br>Core 4: black                           |
| Core construction                |   | 19 x 0.16 mm Ø  |
| Length                           | L | 5 m   |
| Cable code                       |   | Li 7Y 41X 4 x 0,34  |
| Drag chain suitability           |   |   |
| Torsion cycles                   |   | min. 300000   |
| Torsional stress                 |   | ± 360 °/30 cm   |
| <b>Material</b>                  |   |   |
| PWIS free                        |   | yes   |
| Halogen-free                     |   | yes   |
| Plug connector                   |   |   |
| Screw connection                 |   | Zinc diecast, nickel-plated   |
| Body                             |   | TPU, transparent  |
| Seal                             |   | FKM   |
| Contact surface                  |   | gold plated (Au)  |
| Flammability                     |   | V-2   |
| Cable                            |   |   |
| Sheathing                        |   | POC   |
| Core insulation                  |   | ETFE  |
| Welding-bead resistance          |   | yes   |
| Weld spatter resistance          |   | yes   |
| Oil resistance                   |   | yes   |
| Hydrolysis resistance            |   | yes   |
| Flammability                     |   | flame-resistant   |





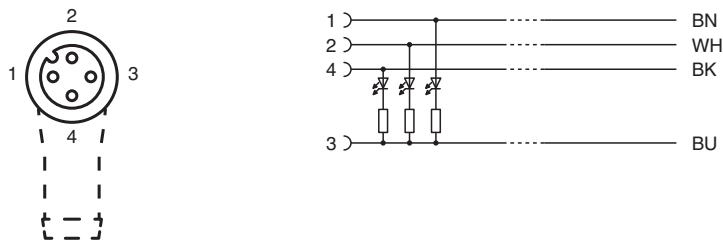

**Technical Data**

|                          |     |
|--------------------------|-----|
| Molecularly cross-linked | yes |
|--------------------------|-----|

**Connection**



**Accessories**

|   |                              |  |
|---|------------------------------|--|
|    | <b>MH V1-SCREWDRIVER</b>     | Torque screwdriver (0.6 Nm)                      |
|    | <b>MH V1-BIT M12</b>         | plug-in cap M12                                  |
|    | <b>V1/V3-LABELHOLDER</b>     | Label holder                                     |
|   | <b>V1/V3-LABEL</b>           | Label plate                                      |
|  | <b>MH V1-Holder</b>          | Modular universal holder for M12 connectors      |
|  | <b>V1-CLIP</b>               | Unlocking protector for M12 connector            |
|  | <b>V1-MARKING-RING-COLOR</b> | Marking rings for M12 connectors, various colors |

Release date: 2023-08-23 Date of issue: 2023-08-23 Filename: 233462\_eng.pdf