

# Female cordset

## V1-W-OR2M-POC

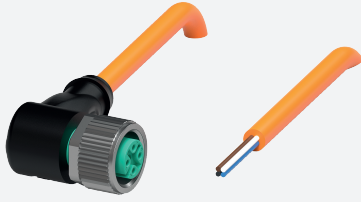

- Welding-bead resistant
- Suitable for robotic applications / torsion resistant
- Degree of protection IP68 / IP69
- Free of paint wetting interfering substances
- Ozone resistant
- Hydrolysis resistant
- Oil resistant
- Halogen-free
- Specific design protects against loosening and inaccurate installation

Female cordset single-ended M12 angled A-coded, 4-pin, POC cable welding-bead resistant orange, suitable for robotic applications, torsion resistant, oil resistant, molecularly cross-linked



### Dimensions

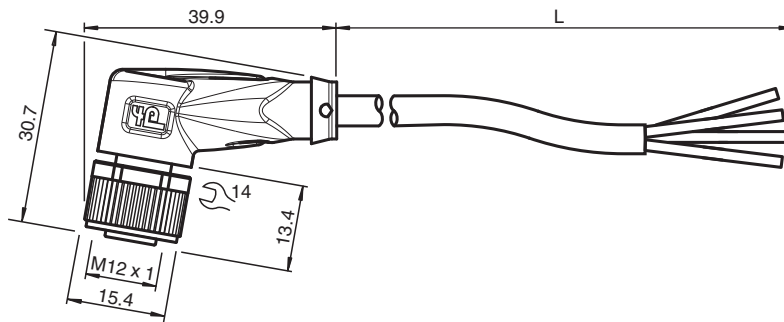

### Technical Data

General specifications		
Connector 1		
Connection		socket
Construction type		M12
Style		angled
Locking		screw connection
Number of pins		4
Coding		A-coded
Connector 2		
Connection		cable end
Electrical specifications		
Operating voltage	$U_B$	max. 250 V AC/DC
Operating current	$I_B$	max. 4 A
Conformity		
Degree of protection		EN 60529
Plug connection		connector M12 x 1 : IEC 61076-2-101
Flammability		IEC 60332-1-2 , ISO 14572 , ISO 6722
Halogen-free		IEC 60754-2
Hydrolysis resistance		ISO 6722
Oil resistance		ISO 14572

Release date: 2023-09-04 Date of issue: 2023-09-05 Filename: 233485\_eng.pdf

## Technical Data





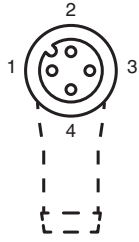

Ambient conditions		
Ambient temperature		
Plug connector		-40 ... 90 °C (-40 ... 194 °F)
Cable, fixed		-40 ... 120 °C (-40 ... 248 °F) for 20000 h -40 ... 150 °C (-40 ... 302 °F) for 3000 h
Cable, flexing		-15 ... 120 °C (5 ... 248 °F) for 20000 h -15 ... 150 °C (5 ... 302 °F) for 3000 h
Pollution degree		3
Mechanical specifications		
Plug connector		
Tightening torque		0.6 Nm
Loosening protection		available
Tool installation		straight knurling and hexagon nut SW = 14 mm
Mating cycles		min. 100
Degree of protection		IP68 / IP69
Cable		
according to IEC/EN 60228 (DIN VDE 0295) class 5		
Sheath diameter		4.8 mm
Bending radius		> 10 x cable diameter, moving > 10 x cable diameter, fixed
Sheath stripping force		max. 50 N / 300 mm
Sheath color		orange (similar to RAL 2003)
Number of cores		4
Core cross section		0.34 mm <sup>2</sup>
Cores color		Core 1: brown Core 2: white Core 3: blue Core 4: black
Core construction		19 x 0.16 mm Ø
Length	L	2 m
Cable code		Li 7Y 41X 4 x 0,34
Drag chain suitability		
Torsion cycles		min. 300000
Torsional stress		± 360 °/30 cm
Material		
PWIS free		yes
Halogen-free		yes
Plug connector		
Screw connection		Zinc diecast, nickel-plated
Body		TPU, black
Seal		FKM
Contact surface		gold plated (Au)
Flammability		V-2
Cable		
Sheathing		POC
Core insulation		ETFE
Welding-bead resistance		yes
Weld spatter resistance		yes
Oil resistance		yes
Hydrolysis resistance		yes
Flammability		flame-resistant
Molecularly cross-linked		yes

**Connection**



- 1 ) ————— BN
- 2 ) ————— WH
- 3 ) ————— BU
- 4 ) ————— BK

**Accessories**

	<b>MH V1-SCREWDRIVER</b>	Torque screwdriver (0.6 Nm)
	<b>MH V1-BIT M12</b>	plug-in cap M12
	<b>V1/V3-LABELHOLDER</b>	Label holder
	<b>V1/V3-LABEL</b>	Label plate
	<b>MH V1-Holder</b>	Modular universal holder for M12 connectors
	<b>V1-CLIP</b>	Unlocking protector for M12 connector
	<b>V1-MARKING-RING-COLOR</b>	Marking rings for M12 connectors, various colors

Release date: 2023-09-04 Date of issue: 2023-09-05 Filename: 233485\_eng.pdf