

Safety edge PSE4-RUB-01

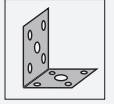

- Rubber profile
- For mounting to ALU mounting strip PSE4-ALU
- Simple to customize to application
- Versions up to 10 m in length are available
- Component of PSE4 modular system

Sensor strip for safety edges from the PSE4 series

Function

In its entirety, the PSE4 safety edge system consists of the control interface, sensors, a rubber sensor strip, and an optional aluminum mounting strip.
 The system can be used within a temperature range of 5 °C to 55 °C.
 The control interface analyzes the signal from the sensors and is designed to be installed in a switch cabinet.
 The safety contact of the control interface is released by actuating the safety edge.
 The system as a whole can be used in applications up to Cat. 4/PL e as defined in EN ISO 13849-1.

Dimensions

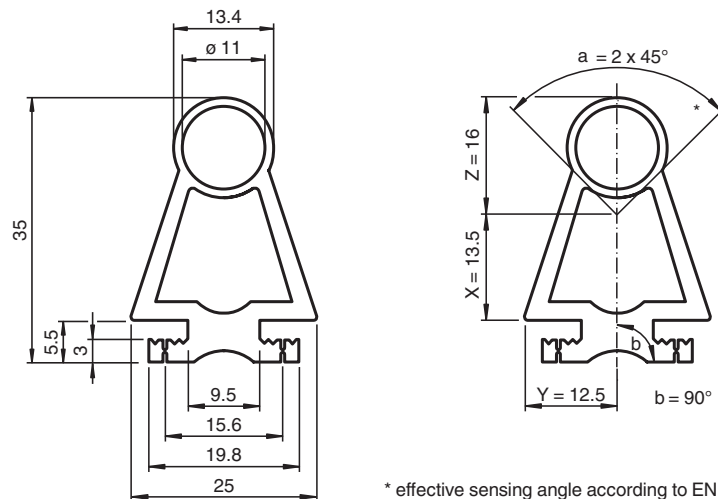

Release date: 2022-05-24 Date of issue: 2022-05-24 Filename: 233901_eng.pdf

Technical Data**General specifications**

Length	1 m
Dead zone	at ends 80 mm

Ambient conditions

Ambient temperature	5 ... 55 °C (41 ... 131 °F)
Environmental resistance	Excellent

Mechanical specifications

Material	EPDM (ethylene propylene diene rubber)
Mass	approx. 300 g

Notes

The modular PSE system comprises the following components:

PSE4-SL safety thru-beam sensors:

The plug electronics are fully encapsulated in the housing to achieve a high level of resistance to environmental influences such as water, dust, and moisture. Degree of protection IP68 is achieved.

Rubber profiles PSE4-RUB and PSE4-ROI:

The rubber profile is designed as a double-chamber profile. The emitter and receiver are inserted in the round hollow chamber at the top. When the profile is actuated, the optical channel is interrupted and the enable circuits on the control unit open. When actuated near the end, the emitter and/or receiver dip into the lower chamber. This ensures that the beam of light is broken. However, the forces required are high, meaning the end areas are inactive areas in line with EN 1760-2.

PSE safety control units:

Controller for the emitter/receiver system.

PSE4-ALU aluminum rails:

The aluminum rails are available in various lengths and can be used as an option.

Functional Principle

The emitter transmits pulses of infrared light, which are detected by the receiver. When the emitter light is detected, the receiver turns off the emitter via a control input. The "luminous flux" stops. The receiver also detects this status and the emitter is then switched on again after a specified time. This coupling produces a dynamic signal that is conveyed, in principle, to a charge pump. The pump's charge state is analyzed in the evaluation.

Any errors in the emitter/receiver system affect the optical or electrical signal, which results in the absence of a dynamic signal.

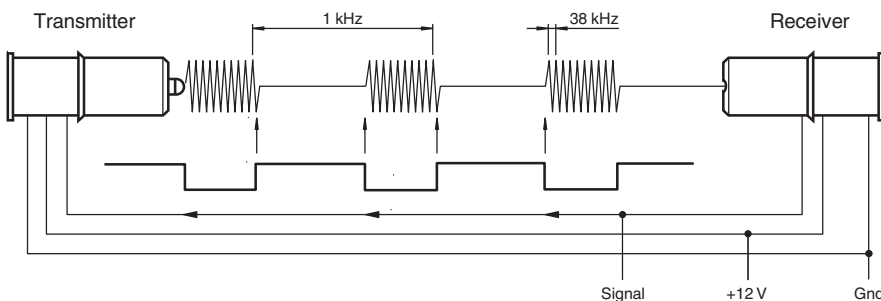

Note:

Safety edges must be fully installed to comply with the EC-Type Examination Certificate for the PSE4 series.

Possible combinations

	PSE4-ALU-*	PSE4-ALU-3009-*	PSE4-ROI-*	PSE4-RUB-*	PSE4-RUB-30EPDM58-*	PSE2-SC-*	PSE4-SC-*	PSE4-SL-*
PSE4-ALU-*			X	X	-	X	X	X
PSE4-ALU-3009-*			-	-	X	X	X	X
PSE4-ROI-*	X	-				X	X	X
PSE4-RUB-*	X	-				X	X	X
PSE4-RUB-30EPDM58-*	-	X				X	X	X
PSE2-SC-*	X	X	X	X	X			X
PSE4-SC-*	X	X	X	X	X			X
PSE4-SL-*	X	X	X	X	X	X	X	

Mounting

Mounting or replacing sensors

Release date: 2022-05-24 Date of issue: 2022-05-24 Filename: 233901_eng.pdf

**Note!**

Measures for vertical mounting

When mounted vertically, the profile must be secured to prevent it from slipping out.

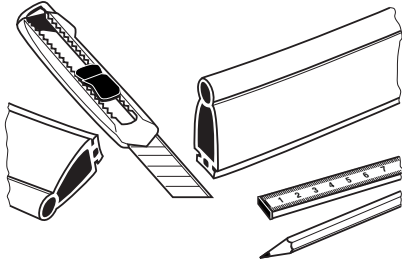

Cut rubber profile PSE4-RUB-XX or PSE4-ROI-XX and the corresponding aluminum mounting strip PSE4-ALU-XX to the required length.

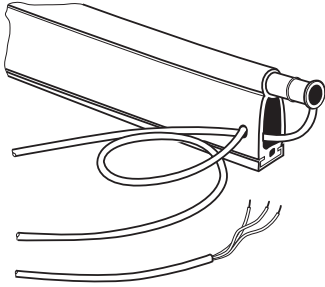

Insert the emitter and receiver into the hollow chamber.
Guide the emitter cable through the second hollow chamber to the receiver side.