

Retroreflective sensor

ML300-55-6m-RT/25/95/120

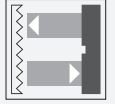

- Miniature design
- Easy to use
- Visible red light
- 45° connector

Retroreflective sensor with polarization filter



Function

The ML300 series has a robust miniature housing and all the standard functional principles. Of particular note are the sensors with analog output, which return a value proportional to the distance. The 45° plug/cable connection ensures flexible mounting. An LED indicates a weak signal, e.g. due to dirt.

Dimensions

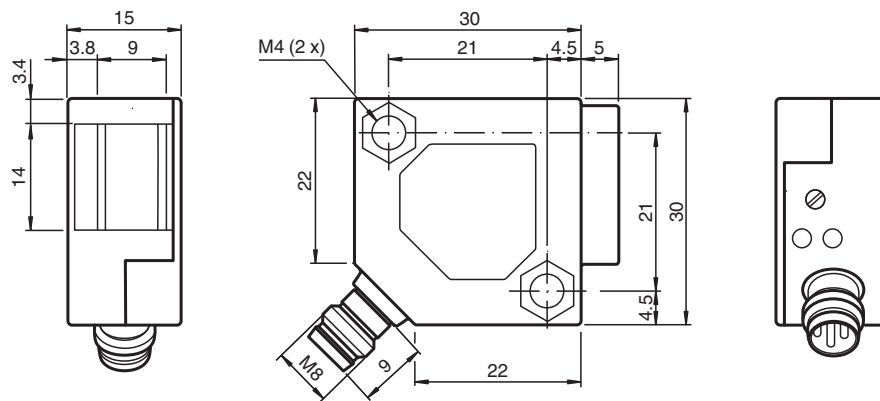

Technical Data

General specifications		
Effective detection range		0 ... 6 m
Reflector distance		0.03 ... 6 m
Threshold detection range		7 m
Reference target		H85-2 reflector
Light source		LED
Light type		modulated visible red light , 660 nm
Polarization filter		yes
Diameter of the light spot		approx. 300 mm at 4 m
Opening angle		approx. 3 °
Ambient light limit		
Continuous light		10000 Lux
Modulated light		5000 Lux
Accessories provided		Mounting bracket OMH-ML300-01
Indicators/operating means		
Function indicator		LED yellow: lights up when output is active LED green: Sufficient stability control
Control elements		sensitivity adjustment
Electrical specifications		
Operating voltage	U_B	10 ... 30 V DC
Ripple		max. 20 %
No-load supply current	I_0	max. 20 mA
Output		
Switching type		light on / dark on
Signal output		2 PNP outputs, complementary, short-circuit protected, reverse polarity protected, open collector
Switching voltage		max. 30 V DC
Switching current		max. 0.1 A
Voltage drop	U_d	≤ 2 V DC
Switching frequency	f	1000 Hz
Response time		0.5 ms
Conformity		
Product standard		EN 60947-5-2
Compliance with standards and directives		
Standard conformity		
Shock and impact resistance		EN 60947-5-7 30 g, 11 ms, all axes
Vibration resistance		EN 60947-5-7, 10-55 Hz/1.5 mm amplitude, all axes
Approvals and certificates		
CCC approval		CCC approval / marking not required for products rated ≤ 36 V
Ambient conditions		
Ambient temperature		-25 ... 55 °C (-13 ... 131 °F)
Mechanical specifications		
Housing width		30 mm
Housing height		30 mm
Housing depth		15 mm
Degree of protection		IP67
Connection		M8 x 1 connector, 4-pin
Material		
Housing		PBT
Optical face		glass pane
Connector		metal
Mass		18 g

Connection Assignment

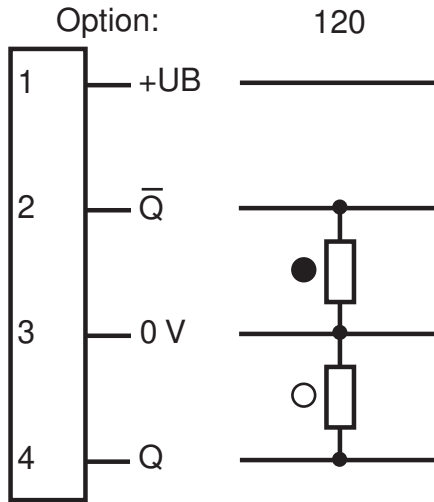

○ = Light on
● = Dark on

Connection Assignment



Wire colors in accordance with EN 60947-5-2

- 1 | BN (brown)
- 2 | WH (white)
- 3 | BU (blue)
- 4 | BK (black)

Assembly

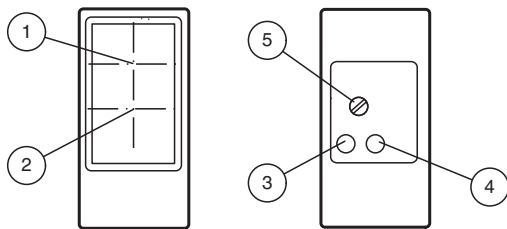

1	Receiver	
2	Emitter	
3	Switching state	yellow
4	Stability control	green
5	Sensitivity adjustment	

Release date: 2023-02-27 Date of issue: 2023-02-27 Filename: 238227_eng.pdf

Characteristic Curve

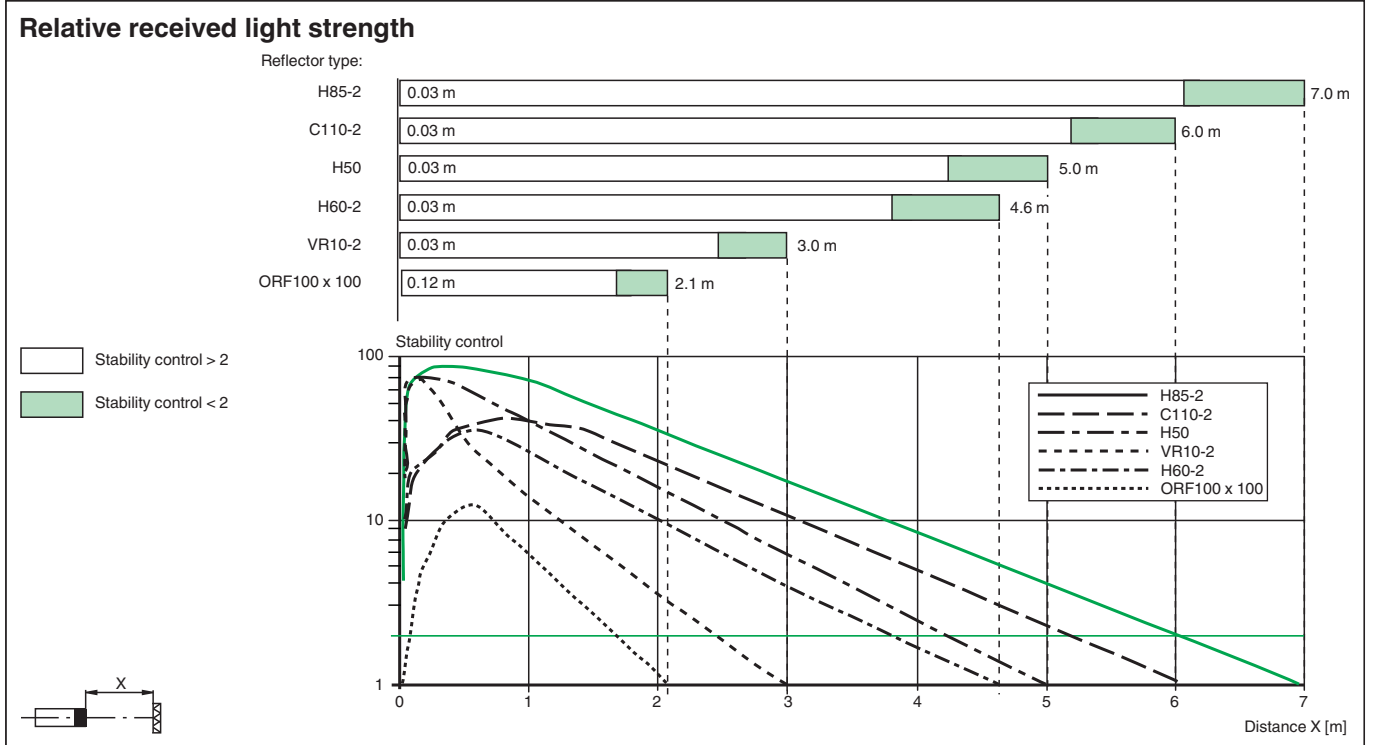
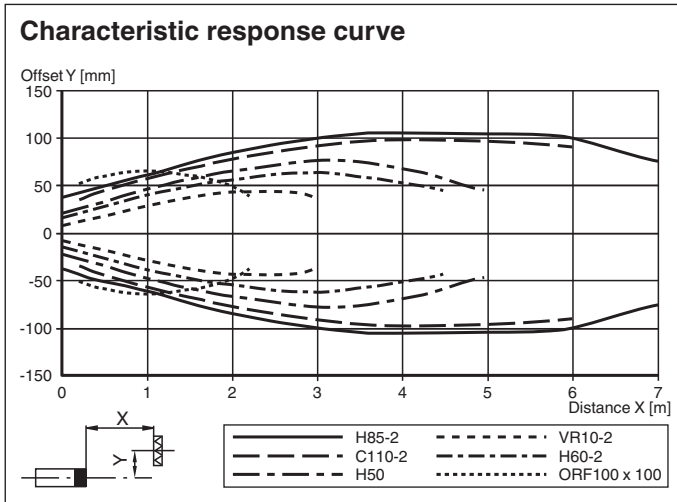





Accessories

	OMH-ML300-01	Bracket for mounting ML300 series sensors
	V31-GM-2M-PVC	Female cordset single-ended M8 straight A-coded, 4-pin, PVC cable grey
	V31-WM-2M-PVC	Female cordset single-ended M8 angled A-coded, 4-pin, PVC cable grey
	V31-WM-2M-PUR	Female cordset single-ended M8 angled A-coded, 4-pin, PUR cable grey
	V31-GM-2M-PUR	Female cordset single-ended M8 straight A-coded, 4-pin, PUR cable grey

Release date: 2023-02-27 Date of issue: 2023-02-27 Filename: 238227_eng.pdf

Accessories

	REF-H85-2	Reflector, rectangular 84.5 mm x 84.5 mm, mounting holes
	REF-C110-2	Reflector, round ø 84 mm, central mounting hole
	REF-H50	Reflector, rectangular 51 mm x 61 mm, mounting holes, fixing strap
	REF-H60-2	Reflector with mounting holes
	OFR-100/100	Reflective tape 100 mm x 100 mm