

Female cordset

V11-W-BK25M-PUR-U



- Suitable for drag chains and abrasion resistant
- Suitable for robotic applications / torsion resistant
- Degree of protection IP68 / IP69
- Free of paint wetting interfering substances
- Resistant to microbes and hydrolysis
- UV resistant
- UL listed for USA and Canada
- Halogen-free
- Specific design protects against loosening and inaccurate installation

Female cordset single-ended M12 angled A-coded, -pin, PUR cable black, UL approved, drag chain suitable, torsion resistant



Dimensions

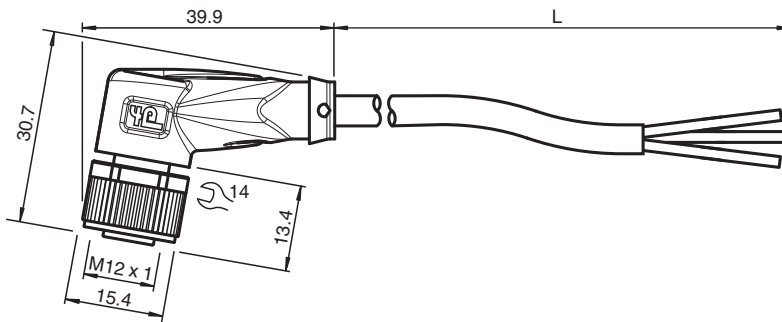

Technical Data

General specifications			
Connector 1			
Connection		socket	
Construction type		M12	
Style		angled	
Locking		screw connection	
Number of pins		3	
Coding		A-coded	
Connector 2			
Connection		cable end	
Electrical specifications			
Operating voltage	U_B	max. 250 V AC/DC	
Operating current	I_B	max. 4 A	
Conformity			
Degree of protection		EN 60529	
Plug connection		connector M12 x 1 : IEC 61076-2-101	
Flammability		UL 1581; DIN EN 60332-2-2	
Halogen-free		IEC 60754-1	
Approvals and certificates			
UL approval		AWM STYLE 20549 AWM I/II A/B 80°C 300V FT2 (cable)	

Release date: 2024-02-21 Date of issue: 2024-02-21 Filename: 239999-0038_eng.pdf

Technical Data

UL File Number		E231213
Ambient conditions		
Ambient temperature		
Plug connector		-40 ... 90 °C (-40 ... 194 °F)
Cable, fixed		-40 ... 80 °C (-40 ... 176 °F)
Cable, flexing		-20 ... 80 °C (-4 ... 176 °F)
Pollution degree		3
Mechanical specifications		
Plug connector		
Tightening torque		0.6 Nm
Loosening protection		available
Tool installation		straight knurling and hexagon nut SW = 14 mm
Mating cycles		min. 100
Degree of protection		IP68 / IP69
Cable		according to IEC/EN 60228 (DIN VDE 0295) class 6
Sheath diameter		Ø 4.3 mm
Bending radius		> 10 x cable diameter, moving > 5 x cable diameter, fixed
Sheath stripping force		max. 80 N / 300 mm
Sheath color		black (similar to RAL 9005)
Number of cores		3
Core cross section		0.34 mm ²
Cores color		Core 1: brown Core 3: blue Core 4: black
Core construction		42 x 0.1 mm Ø
Length	L	25 m
Cable code		Li F 9Y 11Y 3 x 0,34
Drag chain suitability		
Drag chain cycles		min. 5000000
Motion velocity		max. 3.3 m/s
Traverse distance		max. 5 m
Acceleration		max. 5 m/s ²
Torsion cycles		min. 1000000
Torsional stress		± 180 °/m
Material		
PWIS free		yes
Halogen-free		yes
Plug connector		
Screw connection		Zinc diecast, nickel-plated
Body		TPU, black
Seal		FKM
Contact surface		gold plated (Au)
Flammability		V-2
Cable		
Sheathing		PUR based on polyether
Core insulation		PP
UV resistance		yes
Chemical resistance		good
Oil resistance		yes
Cooling lubricant resistance		yes
Microbial resistance		yes
Hydrolysis resistance		yes
Flammability		FT2

Release date: 2024-02-21 Date of issue: 2024-02-21 Filename: 239999-0038_eng.pdf

Connection

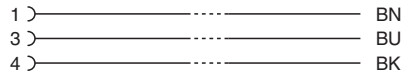
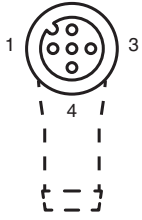

Release date: 2024-02-21 | Date of issue: 2024-02-21 | Filename: 239999-0038_eng.pdf