

Cable socket, shielded

V15-W-BK1M-PUR-U/ABG



- Suitable for drag chains and abrasion resistant
- Degree of protection IP68 / IP69
- Resistant to microbes and hydrolysis
- UV resistant
- UL listed for USA and Canada
- Halogen-free
- Shield connected to screw connection
- Specific design protects against loosening and inaccurate installation

Female cordset single-ended M12 angled A-coded, 5-pin, PUR cable black, shielded, UL approved, drag chain suitable



Dimensions

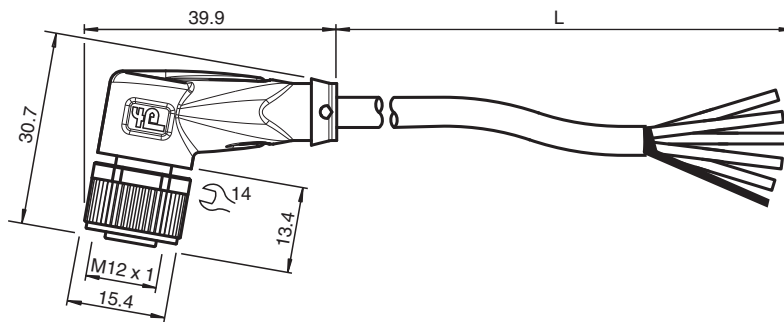

Technical Data

General specifications

Connector 1	
Connection	socket
Construction type	M12
Style	angled
Locking	screw connection
Number of pins	5
Coding	A-coded
Connector 2	
Connection	cable end

Electrical specifications

Operating voltage	U_B	max. 48 V AC / 60 V DC
Operating current	I_B	max. 4 A

Conformity

Degree of protection	EN 60529
Plug connection	connector M12 x 1 : IEC 61076-2-101
Flammability	UL 1581; DIN EN 60332-2-2
Halogen-free	DIN VDE 0472-815
Microbial resistance	EN 50363
Hydrolysis resistance	EN 50363

Approvals and certificates

Release date: 2023-11-06 Date of issue: 2023-11-06 Filename: 240005-100015_eng.pdf

Technical Data

UL approval	AWM STYLE 20549/10493 80°C 300V FT2 (cable)	
UL File Number	E231213	
Ambient conditions		
Ambient temperature		
Plug connector	-40 ... 90 °C (-40 ... 194 °F)	
Cable, fixed	-40 ... 80 °C (-40 ... 176 °F)	
Cable, flexing	-25 ... 80 °C (-13 ... 176 °F)	
Pollution degree	3	
Mechanical specifications		
Plug connector		
Tightening torque	0.6 Nm	
Loosening protection	available	
Tool installation	straight knurling and hexagon nut SW = 14 mm	
Mating cycles	min. 100	
Shielding	shield connected to screw connection	
Degree of protection	IP68 / IP69	
Cable	according to IEC/EN 60228 (DIN VDE 0295) class 6	
Sheath diameter	6 mm	
Bending radius	> 10 x cable diameter, moving > 5 x cable diameter, fixed	
Sheath stripping force	max. 60 N / 100 mm	
Sheath color	black (similar to RAL 9005)	
Number of cores	5	
Core cross section	0.34 mm ²	
Cores color	Core 1: brown Core 2: white Core 3: blue Core 4: black Core 5: grey	
Core construction	42 x 0.1 mm Ø	
Shield	tinned copper braiding, 85 % coverage	
Length	L	1 m
Cable code	Li F 9Y C11Y 5 x 0,34	
Drag chain suitability		
Drag chain cycles	min. 2000000	
Motion velocity	max. 3 m/s	
Traverse distance	max. 5 m	
Acceleration	max. 5 m/s ²	
Material		
Halogen-free	yes	
Plug connector		
Screw connection	Zinc diecast, nickel-plated	
Body	TPU, black	
Seal	FKM	
Contact surface	gold plated (Au)	
Flammability	V-2	
Cable		
Sheathing	PUR based on polyether	
Core insulation	PP	
UV resistance	yes	
Chemical resistance	good	
Oil resistance	yes	
Cooling lubricant resistance	yes	
Microbial resistance	yes	
Hydrolysis resistance	yes	

Release date: 2023-11-06 Date of issue: 2023-11-06 Filename: 240005-100015_eng.pdf

Technical Data

Flammability

FT2

Connection

