

# Female cordset

## V1-WV4A-2M-PVC

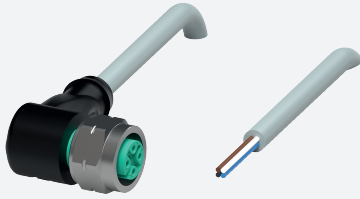

- Degree of protection IP68 / IP69
- Screw connection stainless steel
- Specific design protects against loosening and inaccurate installation

Female cordset single-ended M12 angled stainless steel 1.4404, A-coded, 4-pin, PVC cable grey



### Dimensions

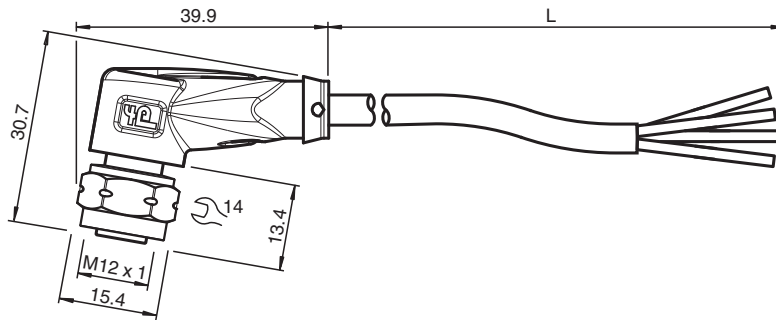

### Technical Data

#### General specifications

<b>Connector 1</b>		
Connection		socket
Construction type		M12
Style		angled
Locking		screw connection
Number of pins		4
Coding		A-coded
<b>Connector 2</b>		
Connection		cable end

#### Electrical specifications

Operating voltage	$U_B$	max. 250 V AC/DC
Operating current	$I_B$	max. 4 A

#### Conformity

Degree of protection		EN 60529
Plug connection		connector M12 x 1 : IEC 61076-2-101
Flammability		IEC 60332-2-2

#### Ambient conditions

<b>Ambient temperature</b>		
Plug connector		-40 ... 90 °C (-40 ... 194 °F)
Cable, fixed		-25 ... 70 °C (-13 ... 158 °F)

Release date: 2023-09-05 Date of issue: 2023-09-05 Filename: 240768-0006\_eng.pdf

## Technical Data

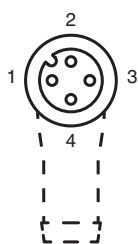

Cable, flexing	-5 ... 70 °C (23 ... 158 °F)	
Pollution degree	3	
<b>Mechanical specifications</b>		
Plug connector		
Tightening torque	0.6 Nm	
Loosening protection	available	
Tool installation	hexagon nut SW = 14 mm	
Mating cycles	min. 100	
Degree of protection	IP68 / IP69	
Cable	according to IEC/EN 60228 (DIN VDE 0295) class 5	
Sheath diameter	4.8 mm	
Bending radius	> 10 x cable diameter, moving	
Sheath stripping force	max. 80 N / 300 mm	
Sheath color	grey (similar to RAL 7001)	
Number of cores	4	
Core cross section	0.34 mm <sup>2</sup>	
Cores color	Core 1: brown Core 2: white Core 3: blue Core 4: black	
Core construction	19 x 0.15 mm Ø	
Length	L	2 m
Cable code	Li Y YM 4 x 0,34	
<b>Material</b>		
Plug connector		
Screw connection	Stainless steel 1.4404 / AISI 316L	
Body	TPU, black	
Seal	FKM	
Contact surface	gold plated (Au)	
Flammability	V-2	
Cable		
Sheathing	PVC	
Core insulation	PVC	
Flammability	flame-resistant	

## Connection







1	—	BN
2	—	WH
3	—	BU
4	—	BK

## Accessories

	<b>MH V1-SCREWDRIVER</b>	Torque screwdriver (0.6 Nm)
	<b>MH V1-BIT M12-W14-HEX</b>	Plug-in attachment for M12 with hex stainless steel knurled nut

**Accessories**

	<b>V1/V3-LABELHOLDER</b>	Label holder
	<b>V1/V3-LABEL</b>	Label plate
	<b>MH V1-Holder</b>	Modular universal holder for M12 connectors
	<b>V1-CLIP</b>	Unlocking protector for M12 connector
	<b>V1-MARKING-RING-COLOR</b>	Marking rings for M12 connectors, various colors