

Female cordset

V1-WV4A-25M-PVC

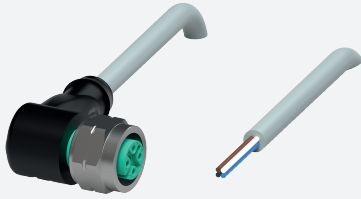

- Degree of protection IP68 / IP69
- Screw connection stainless steel
- Specific design protects against loosening and inaccurate installation

Female cordset single-ended M12 angled stainless steel 1.4404, A-coded, 4-pin, PVC cable grey



Dimensions

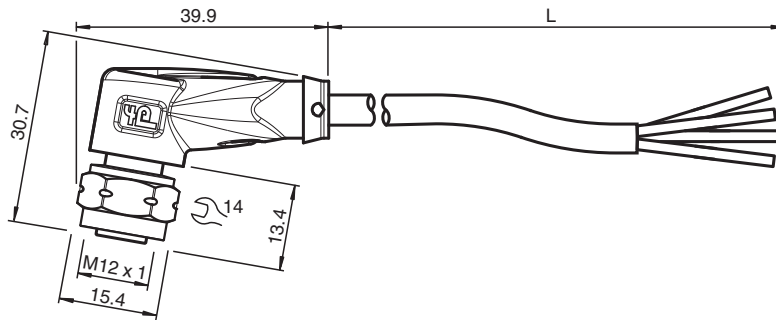

Technical Data

General specifications

Connector 1		
Connection		socket
Construction type		M12
Style		angled
Locking		screw connection
Number of pins		4
Coding		A-coded
Connector 2		
Connection		cable end

Electrical specifications

Operating voltage	U_B	max. 250 V AC/DC
Operating current	I_B	max. 4 A

Conformity

Degree of protection		EN 60529
Plug connection		connector M12 x 1 : IEC 61076-2-101
Flammability		IEC 60332-2-2

Ambient conditions

Ambient temperature		
Plug connector		-40 ... 90 °C (-40 ... 194 °F)
Cable, fixed		-25 ... 70 °C (-13 ... 158 °F)

Release date: 2023-09-05 Date of issue: 2023-09-05 Filename: 240768-100000_eng.pdf

Technical Data

Cable, flexing	-5 ... 70 °C (23 ... 158 °F)	
Pollution degree	3	
Mechanical specifications		
Plug connector		
Tightening torque	0.6 Nm	
Loosening protection	available	
Tool installation	hexagon nut SW = 14 mm	
Mating cycles	min. 100	
Degree of protection	IP68 / IP69	
Cable	according to IEC/EN 60228 (DIN VDE 0295) class 5	
Sheath diameter	4.8 mm	
Bending radius	> 10 x cable diameter, moving	
Sheath stripping force	max. 80 N / 300 mm	
Sheath color	grey (similar to RAL 7001)	
Number of cores	4	
Core cross section	0.34 mm ²	
Cores color	Core 1: brown Core 2: white Core 3: blue Core 4: black	
Core construction	19 x 0.15 mm Ø	
Length	L	25 m
Cable code	Li Y YM 4 x 0,34	
Material		
Plug connector		
Screw connection	Stainless steel 1.4404 / AISI 316L	
Body	TPU, black	
Seal	FKM	
Contact surface	gold plated (Au)	
Flammability	V-2	
Cable		
Sheathing	PVC	
Core insulation	PVC	
Flammability	flame-resistant	

Connection

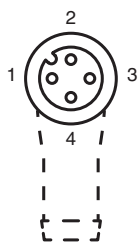





1	BN
2	WH
3	BU
4	BK

Accessories

	MH V1-SCREWDRIVER	Torque screwdriver (0.6 Nm)
	MH V1-BIT M12-W14-HEX	Plug-in attachment for M12 with hex stainless steel knurled nut

Accessories

	V1/V3-LABELHOLDER	Label holder
	V1/V3-LABEL	Label plate
	MH V1-Holder	Modular universal holder for M12 connectors
	V1-CLIP	Unlocking protector for M12 connector
	V1-MARKING-RING-COLOR	Marking rings for M12 connectors, various colors