

Cable connector

V1S-W-BK5M-PUR-U



- Suitable for drag chains and abrasion resistant
- Suitable for robotic applications / torsion resistant
- Degree of protection IP68 / IP69
- Free of paint wetting interfering substances
- Resistant to microbes and hydrolysis
- UV resistant
- UL listed for USA and Canada
- Halogen-free
- Specific design protects against loosening and inaccurate installation

Male cordset single-ended M12 angled A-coded, 4-pin, PUR cable black, UL-approved, drag chain suitable, torsion resistant



Dimensions

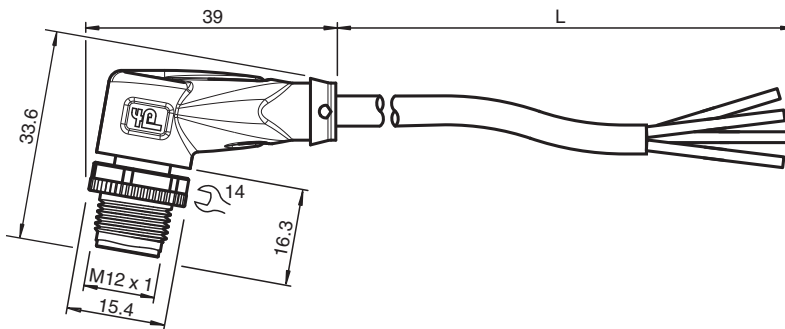

Technical Data

General specifications

Connector 1		
Connection		plug
Construction type		M12
Style		angled
Locking		screw connection
Number of pins		4
Coding		A-coded
Connector 2		
Connection		cable end

Electrical specifications

Operating voltage	U_B	max. 250 V AC/DC
Operating current	I_B	max. 4 A

Conformity

Degree of protection		EN 60529
Plug connection		connector M12 x 1 : IEC 61076-2-101
Flammability		UL 1581; DIN EN 60332-2-2
Halogen-free		IEC 60754-1

Approvals and certificates

UL approval		AWM STYLE 20549 AWM I/II A/B 80°C 300V FT2 (cable)
-------------	--	--

Release date: 2023-08-10 Date of issue: 2023-08-10 Filename: 240772-100016_eng.pdf

Technical Data

UL File Number		E231213
Ambient conditions		
Ambient temperature		
Plug connector		-40 ... 90 °C (-40 ... 194 °F)
Cable, fixed		-40 ... 80 °C (-40 ... 176 °F)
Cable, flexing		-20 ... 80 °C (-4 ... 176 °F)
Pollution degree		3
Mechanical specifications		
Plug connector		
Tightening torque		0.6 Nm
Loosening protection		available
Tool installation		straight knurling and hexagon nut SW = 14 mm
Mating cycles		min. 100
Degree of protection		IP68 / IP69
Cable		according to IEC/EN 60228 (DIN VDE 0295) class 6
Sheath diameter		4.3 mm
Bending radius		> 10 x cable diameter, moving > 5 x cable diameter, fixed
Sheath stripping force		max. 80 N / 300 mm
Sheath color		black (similar to RAL 9005)
Number of cores		4
Core cross section		0.34 mm ²
Cores color		Core 1: brown Core 2: white Core 3: blue Core 4: black
Core construction		42 x 0.1 mm Ø
Length	L	5 m
Cable code		Li 9Y 11Y 4 x 0.34
Drag chain suitability		
Drag chain cycles		min. 5000000
Motion velocity		max. 3.3 m/s
Traverse distance		max. 5 m
Acceleration		max. 5 m/s ²
Torsion cycles		min. 1000000
Torsional stress		± 180 °/m
Material		
PWIS free		yes
Halogen-free		yes
Plug connector		
Screw connection		Zinc diecast, nickel-plated
Body		TPU, black
Contact surface		gold plated (Au)
Flammability		V-2
Cable		
Sheathing		PUR based on polyether
Core insulation		PP
UV resistance		yes
Chemical resistance		good
Oil resistance		yes
Cooling lubricant resistance		yes
Microbial resistance		yes
Hydrolysis resistance		yes
Flammability		FT2





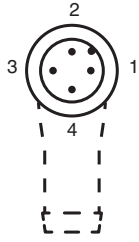

Release date: 2023-08-10 Date of issue: 2023-08-10 Filename: 240772-100016_eng.pdf

Connection



- 1 ————— BN
- 2 ————— WH
- 3 ————— BU
- 4 ————— BK

Accessories

	MH V1-SCREWDRIVER	Torque screwdriver (0.6 Nm)
	MH V1-BIT M12	plug-in cap M12
	V1/V3-LABELHOLDER	Label holder
	V1/V3-LABEL	Label plate
	MH V1-Holder	Modular universal holder for M12 connectors
	V1-CLIP	Unlocking protector for M12 connector
	V1-MARKING-RING-COLOR	Marking rings for M12 connectors, various colors

Release date: 2023-08-10 Date of issue: 2023-08-10 Filename: 240772-100016_eng.pdf