

# Connection cable

## V1-W-BK5M-PVC-U-V1-W



- Degree of protection IP68 / IP69
- UL listed for USA and Canada
- Specific design protects against loosening and inaccurate installation

Cordset M12 socket angled to M12 plug angled A-coded, 4-pin, PVC cable black, UL approved



### Dimensions

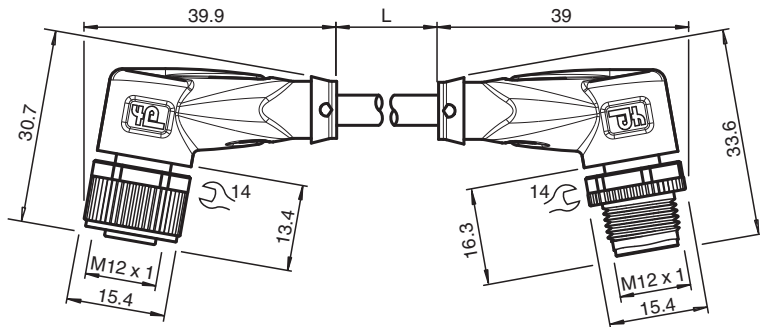

### Technical Data

General specifications		
Connector 1		
Connection		socket
Construction type		M12
Style		angled
Locking		screw connection
Number of pins		4
Coding		A-coded
Connector 2		
Connection		plug
Construction type		M12
Style		angled
Locking		screw connection
Number of pins		4
Coding		A-coded
Electrical specifications		
Operating voltage	$U_B$	max. 250 V AC/DC
Operating current	$I_B$	max. 4 A
Conformity		
Degree of protection		EN 60529
Plug connection		connector M12 x 1 : IEC 61076-2-101

Release date: 2023-07-13 Date of issue: 2023-07-13 Filename: 240777-100008\_eng.pdf

## Technical Data

Flammability	UL 1581 , IEC 60332-1-2	
<b>Approvals and certificates</b>		
UL approval	AWM STYLE 2095 AWM I/II A/B 80°C 300V FT1 (cable)	
UL File Number	E231213	
<b>Ambient conditions</b>		
Ambient temperature		
Plug connector	-40 ... 90 °C (-40 ... 194 °F)	
Cable, fixed	-25 ... 80 °C (-13 ... 176 °F)	
Cable, flexing	-5 ... 80 °C (23 ... 176 °F)	
Pollution degree	3	
<b>Mechanical specifications</b>		
Plug connector		
Tightening torque	0.6 Nm	
Loosening protection	available	
Tool installation	straight knurling and hexagon nut SW = 14 mm	
Mating cycles	min. 100	
Degree of protection	IP68 / IP69	
Cable	according to IEC/EN 60228 (DIN VDE 0295) class 5	
Sheath diameter	4.3 mm	
Bending radius	> 15 x cable diameter, moving > 5 x cable diameter, fixed	
Sheath stripping force	max. 50 N / 300 mm	
Sheath color	black (similar to RAL 9005)	
Number of cores	4	
Core cross section	0.34 mm <sup>2</sup>	
Cores color	Core 1: brown Core 2: white Core 3: blue Core 4: black	
Core construction	19 x 0.15 mm Ø	
Length	L	5 m
Cable code	Li YY 4 x 0,34	
<b>Material</b>		
Plug connector		
Screw connection	Zinc diecast, nickel-plated	
Body	TPU, black	
Seal	FKM	
Contact surface	gold plated (Au)	
Flammability	V-2	
Cable		
Sheathing	PVC	
Core insulation	PVC	
Flammability	FT1	

## Connection

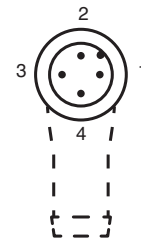
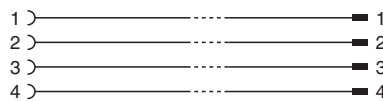
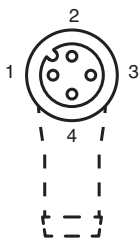

## Accessories

	<b>MH V1-SCREWDRIVER</b>	Torque screwdriver (0.6 Nm)
	<b>MH V1-BIT M12</b>	plug-in cap M12
	<b>V1/V3-LABELHOLDER</b>	Label holder
	<b>V1/V3-LABEL</b>	Label plate
	<b>MH V1-Holder</b>	Modular universal holder for M12 connectors
	<b>V1-CLIP</b>	Unlocking protector for M12 connector
	<b>V1-MARKING-RING-COLOR</b>	Marking rings for M12 connectors, various colors