

# Female cordset

## V31-WM-BK1,5M-PUR-U



- Suitable for drag chains and abrasion resistant
- Suitable for robotic applications / torsion resistant
- Degree of protection IP68
- Free of paint wetting interfering substances
- Resistant to microbes and hydrolysis
- UV resistant
- UL listed for USA and Canada
- Halogen-free
- Specific design protects against loosening and inaccurate installation

Female cordset single-ended M8 angled A-coded, 4-pin, PUR cable black, UL approved, drag chain suitable, torsion resistant



### Dimensions

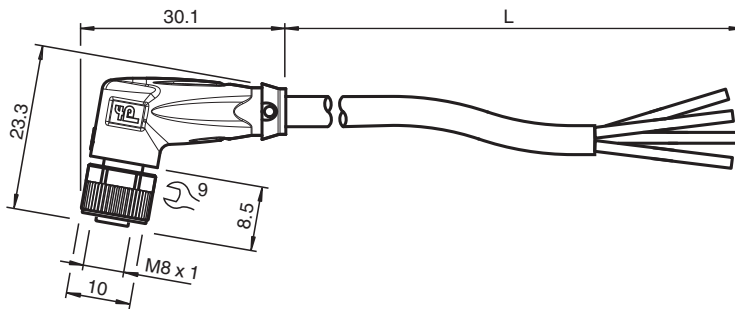

### Technical Data

General specifications			
Connector 1			
Connection		socket	
Construction type		M8	
Style		angled	
Locking		screw connection	
Number of pins		4	
Coding		A-coded	
Connector 2			
Connection		cable end	
Electrical specifications			
Operating voltage	$U_B$	max. 30 V AC/DC	
Operating current	$I_B$	max. 4 A	
Conformity			
Degree of protection		EN 60529	
Plug connection		connector M8 x 1 : IEC 61076-2-104	
Flammability		UL 1581; DIN EN 60332-2-2	
Halogen-free		IEC 60754-1	
Approvals and certificates			
UL approval		AWM STYLE 20549 AWM I/II A/B 80°C 300V FT2 (cable)	
UL File Number		E231213	

Release date: 2023-09-05 Date of issue: 2023-09-05 Filename: 240800-0005\_eng.pdf

## Technical Data

### Ambient conditions

Ambient temperature		
Plug connector		-40 ... 90 °C (-40 ... 194 °F)
Cable, fixed		-40 ... 80 °C (-40 ... 176 °F)
Cable, flexing		-20 ... 80 °C (-4 ... 176 °F)
Pollution degree		3

### Mechanical specifications

Plug connector		
Tightening torque		0.4 Nm
Loosening protection		available
Tool installation		straight knurling and hexagon nut SW = 9 mm
Mating cycles		min. 100
Degree of protection		IP68
Cable		according to IEC/EN 60228 (DIN VDE 0295) class 6
Sheath diameter		4.3 mm
Bending radius		> 10 x cable diameter, moving > 5 x cable diameter, fixed
Sheath stripping force		max. 80 N / 300 mm
Sheath color		black (similar to RAL 9005)
Number of cores		4
Core cross section		0.34 mm <sup>2</sup>
Cores color		Core 1: brown Core 2: white Core 3: blue Core 4: black
Core construction		42 x 0.1 mm Ø
Length	L	1.5 m
Cable code		Li 9Y 11Y 4 x 0.34
Drag chain suitability		
Drag chain cycles		min. 5000000
Motion velocity		max. 3.3 m/s
Traverse distance		max. 5 m
Acceleration		max. 5 m/s <sup>2</sup>
Torsion cycles		min. 1000000
Torsional stress		± 180 °/m

### Material



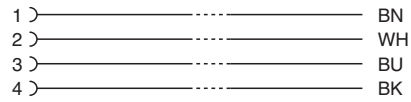
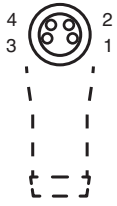

PWIS free		yes
Halogen-free		yes
Plug connector		
Screw connection		Zinc diecast, nickel-plated
Body		TPU, black
Seal		FKM
Contact surface		gold plated (Au)
Flammability		V-2
Cable		
Sheathing		PUR based on polyether
Core insulation		PP
UV resistance		yes
Chemical resistance		good
Oil resistance		yes
Cooling lubricant resistance		yes
Microbial resistance		yes
Hydrolysis resistance		yes
Flammability		FT2

Release date: 2023-09-05 Date of issue: 2023-09-05 Filename: 240800-0005\_eng.pdf

## Connection



## Accessories

	<b>MH V3-SCREWDRIVER</b>	Torque screwdriver (0.4 Nm)
	<b>MH V3-BIT M8</b>	plug-in cap for M8
	<b>V1/V3-LABELHOLDER</b>	Label holder
	<b>V1/V3-LABEL</b>	Label plate
	<b>MH V3-Holder</b>	Modular universal holder for M8 connectors