

Connection cable

V31-WM-10M-PUR-V31-GM



- Degree of protection IP68
- Resistant to microbes and hydrolysis
- Halogen-free
- Specific design protects against loosening and inaccurate installation

Cordset M8 socket angled to M8 plug straight A-coded, 4-pin, PUR cable grey



Dimensions

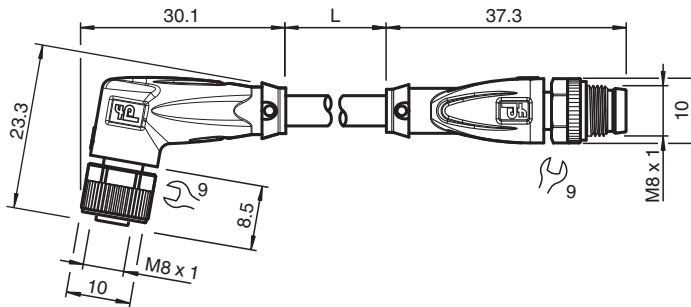

Technical Data

General specifications

Connector 1		
Connection		socket
Construction type		M8
Style		angled
Locking		screw connection
Number of pins		4
Coding		A-coded
Connector 2		
Connection		plug
Construction type		M8
Style		straight
Locking		screw connection
Number of pins		4
Coding		A-coded

Electrical specifications

Operating voltage	U_B	max. 30 V AC/DC
Operating current	I_B	max. 3 A

Conformity

Degree of protection		EN 60529
Plug connection		connector M8 x 1 : IEC 61076-2-104
Halogen-free		IEC 60754-1

Release date: 2023-06-29 Date of issue: 2023-06-29 Filename: 240815-100007_eng.pdf

Technical Data

Ambient conditions

Ambient temperature

Plug connector	-40 ... 90 °C (-40 ... 194 °F)
Cable, fixed	-40 ... 80 °C (-40 ... 176 °F)
Cable, flexing	-20 ... 80 °C (-4 ... 176 °F)

Pollution degree 3

Mechanical specifications

Plug connector

Tightening torque	0.4 Nm
Loosening protection	available
Tool installation	straight knurling and hexagon nut SW = 14 mm
Mating cycles	min. 100
Degree of protection	IP68

Cable

according to IEC/EN 60228 (DIN VDE 0295) class 5

Sheath diameter	4.3 mm
Bending radius	> 15 x cable diameter, moving > 8 x cable diameter, fixed
Sheath stripping force	max. 60 N / 500 mm
Sheath color	grey (similar to RAL 7001)
Number of cores	4
Core cross section	0.25 mm ²
Cores color	Core 1: brown Core 2: white Core 3: blue Core 4: black
Core construction	14 x 0.15 mm Ø

Length	L	10 m
Cable code		Li 9Y 11Y 4 x 0,25

Drag chain suitability

Drag chain cycles	max. 50 / day
Motion velocity	max. 0.3 m/s

Material

Halogen-free	yes
Plug connector	
Screw connection	Zinc diecast, nickel-plated
Body	TPU, black
Seal	FKM
Contact surface	gold plated (Au)
Flammability	V-2



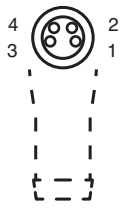

Cable

Sheathing	PUR based on polyether
Core insulation	PP
Chemical resistance	good
Microbial resistance	yes
Hydrolysis resistance	yes

Connection



Accessories

	MH V3-SCREWDRIVER	Torque screwdriver (0.4 Nm)
	MH V3-BIT M8	plug-in cap for M8
	V1/V3-LABELHOLDER	Label holder
	V1/V3-LABEL	Label plate
	MH V3-Holder	Modular universal holder for M8 connectors