

Inclination sensor

INY060D-F99-2I2E2-V17



- Analog output 4 mA ... 20 mA
- Fixed evaluation limits
- High shock resistance
- Increased noise immunity 100 V/m
- Measuring range -30° ... +30°



Dimensions

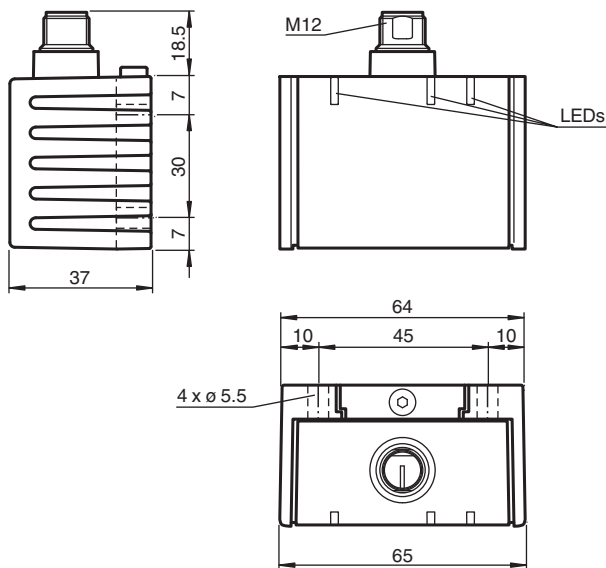

Technical Data

General specifications

Type	Inclination sensor, 2-axis
Measurement range	-30 ... 30 °
Absolute accuracy	≤ ± 0.2 °
Response delay	≤ 25 ms
Resolution	≤ 0.02 °
Repeat accuracy	≤ ± 0.04 °
Temperature influence	≤ 0.004 °/K

Functional safety related parameters

Technical Data

MTTF _d		304 a
Mission Time (T _M)		20 a
Diagnostic Coverage (DC)		0 %
Indicators/operating means		
Operation indicator		LED, green
Switching state		2 yellow LEDs: Switching status (each output)
Electrical specifications		
Operating voltage	U _B	10 ... 30 V DC
No-load supply current	I ₀	≤ 25 mA
Time delay before availability	t _v	≤ 200 ms
Switching output		
Output type		2 switch outputs PNP, NO , reverse polarity protected , short-circuit protected
Operating current	I _L	≤ 100 mA
Voltage drop		≤ 3 V
Analog output		
Output type		2 current outputs 4 ... 20 mA (one output for each axis)
Load resistor		0 ... 200 Ω at U _B = 10 ... 18 V 0 ... 500 Ω at U _B = 18 ... 30 V
Compliance with standards and directives		
Standard conformity		
Shock and impact resistance		100 g according to DIN EN 60068-2-27
Standards		EN 60947-5-2:2007 IEC 60947-5-2:2007
Approvals and certificates		
UL approval		cULus Listed, Class 2 Power Source
Ambient conditions		
Ambient temperature		-40 ... 85 °C (-40 ... 185 °F)
Storage temperature		-40 ... 85 °C (-40 ... 185 °F)
Mechanical specifications		
Connection type		8-pin, M12 x 1 connector
Housing material		PA
Degree of protection		IP68 / IP69K
Mass		240 g
Factory settings		
Analog output (X)		-30 ° ... 30 °
Analog output (Y)		-30 ° ... 30 °
Switching output (X)		-30 ° ... 30 °
Switching output (Y)		-30 ° ... 30 °

Connection

Standard symbol/Connection:

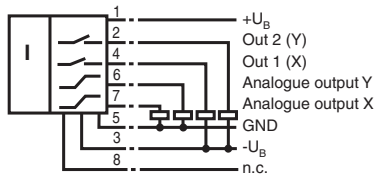

Connection Assignment

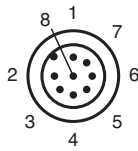

Wire colors

1	WH	(white)
2	BN	(brown)
3	GN	(green)
4	YE	(yellow)
5	GY	(gray)
6	PK	(pink)
7	BU	(blue)
8	RD	(red)

Accessories

	V17-G-2M-PUR	Female cordset, M12, 8-pin, shielded, PUR cable
	V17-G-5M-PUR	Female cordset, M12, 8-pin, shielded, PUR cable
	V17-G-10M-PUR	Female cordset, M12, 8-pin, shielded, PUR cable
	V17-G-10M-PVC-ABG	Female cordset, M12, 8-pin, shielded, PVC cable

Release date: 2020-04-24 Date of issue: 2020-06-03 Filename: 241157_eng.pdf

Mounting

Sensor Orientation

In the default setting the zero position of the sensor is reached, when the sensor is mounted on a horizontal plane and electrical connection faces sideways.

Mounting

X Orientation

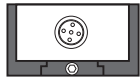

X = 0°

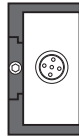

X = 90°

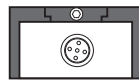

X = ±180°



X = 270° (-)

Mounting

Y Orientation

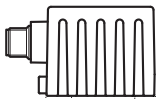

Y = 0°



Y = 90°

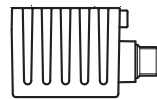

Y = ±180°



Y = 270° (-)

Mounting

Mounting of the sensor

Sensors from the -F99 series consist of a sensor module and accompanying cast aluminum housing. Select a horizontal flat surface with minimum dimensions of 70 mm x 50 mm to mount the sensor.

Mount the sensor as follows:

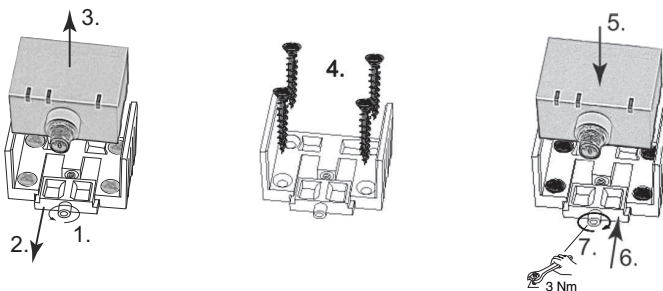

1. Loosen the central screw under the sensor connection.
2. Slide back the clamping element until you are able to remove the sensor module from the housing.
3. Remove the sensor module from the housing
4. Position the housing at the required mounting location and secure using four countersunk screws. Make sure that the heads of the screws do not protrude.
5. Place the sensor module in the housing.
6. Slide the clamping element flush into the housing. Check that the sensor element is seated correctly.
7. Finally tighten the central screw.
The sensor is now mounted correctly.