

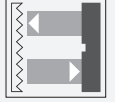

## Retroreflective sensor MLV41-55/25/70/136



- Rugged series in corrosion-resistant metal housing
- Extremely high switching frequency
- Clear and functional display concept for the operating modes
- Resistant against noise: reliable operation under all conditions
- Aluminum housing with high quality Delta-Seal coated

Robust retroreflective sensor with polarization filter, compact housing design, 8 m detection range, red light, 2 push-pull outputs, M9 plug



### Function

The unique and extremely popular design of the MLV41 series enables it to be mounted correctly in confined areas and offers all the functions that are normally only found on larger photoelectric sensors. The MLV41 series comes with a range of functions. For example, highly visible status LEDs on the front and back, resistance to ambient light, crosstalk protection and universally applicable output stages that permit every possible switching logic and polarity to be realized. The enhanced resistance to ambient light ensures reliable operation even where modern energy-saving lamps with electronic ballasts are in use. The same applies where multiple devices are present, i.e. the use of a number of sensors in the same vicinity causes no problems.

## Dimensions

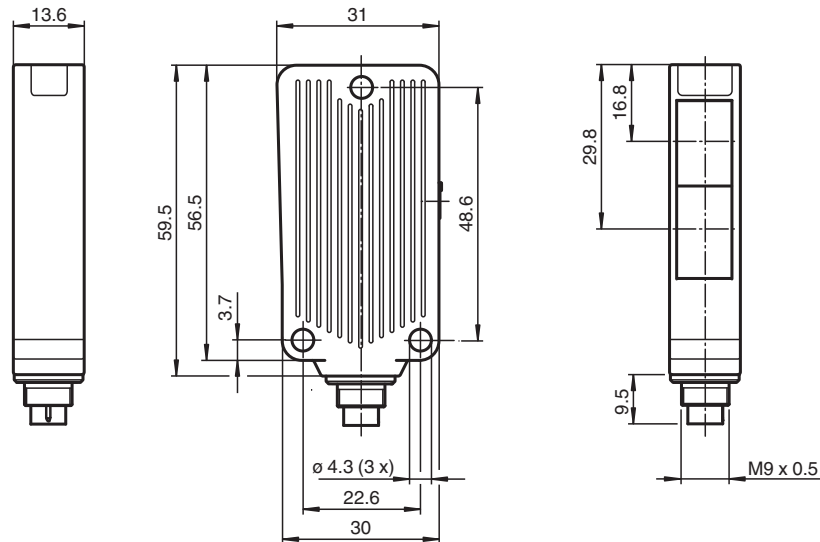

## Technical Data

General specifications	
Effective detection range	0 ... 8 m
Reflector distance	0.1 ... 8 m
Threshold detection range	10 m
Reference target	H85-2 reflector
Light source	LED
Light type	modulated visible red light , 625 nm
Polarization filter	yes
Angle deviation	max. $\pm 1.5^\circ$
Diameter of the light spot	approx. 300 mm at detection range 8.5 m
Opening angle	$1.5^\circ$
Optical face	frontal
Ambient light limit	20000 Lux
Functional safety related parameters	
MTTF <sub>d</sub>	844 a
Mission Time (T <sub>M</sub> )	20 a
Diagnostic Coverage (DC)	0 %
Indicators/operating means	
Operation indicator	LED green, statically lit Power on , Undervoltage indicator: Green LED, pulsing (approx. 0.8 Hz) , short-circuit : LED green flashing (approx. 4 Hz)
Function indicator	LED yellow, lights up when light beam is free, flashes when falling short of the operating reserve

Release date: 2023-03-28 Date of issue: 2023-03-28 Filename: 244371\_eng.pdf

## Technical Data

Control elements		none
<b>Electrical specifications</b>		
Operating voltage	$U_B$	10 ... 30 V DC
Ripple		max. 10 %
No-load supply current	$I_0$	max. 30 mA
<b>Output</b>		
Signal output		2 push-pull (4 in 1) outputs, complementary, short-circuit proof, reverse polarity protected
Switching voltage		max. 30 V DC
Switching current		max. 100 mA
Voltage drop	$U_d$	$\leq 2.5$ V DC
Switching frequency	$f$	1000 Hz
Response time		0.5 ms
<b>Conformity</b>		
Product standard		EN 60947-5-2
<b>Approvals and certificates</b>		
UL approval		cULus Listed 57M3 (Only in association with UL Class 2 power supply; Type 1 enclosure)
CCC approval		CCC approval / marking not required for products rated $\leq 36$ V
<b>Ambient conditions</b>		
Ambient temperature		-40 ... 60 °C (-40 ... 140 °F)
Storage temperature		-40 ... 75 °C (-40 ... 167 °F)
<b>Mechanical specifications</b>		
Housing width		31 mm
Housing height		56.5 mm
Housing depth		13.6 mm
Degree of protection		IP67
Connection		with M9, 5-pin metal connector
Material		
Housing		Aluminum , Delta-Seal coated
Optical face		glass pane
Connector		metal
Mass		50 g

## Connection Assignment

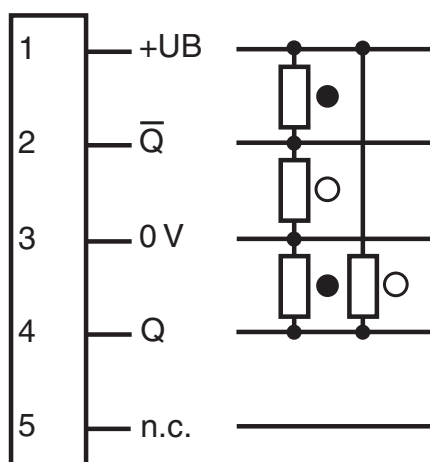

○ = Light on  
● = Dark on

### Note:

In the case of replacements for MLV40, the differing pin assignment (EURO standard) must be taken into account

## Connection Assignment

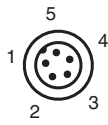

Wire colors in accordance with EN 60947-5-2

1	BN	(brown)
2	WH	(white)
3	BU	(blue)
4	BK	(black)

## Assembly

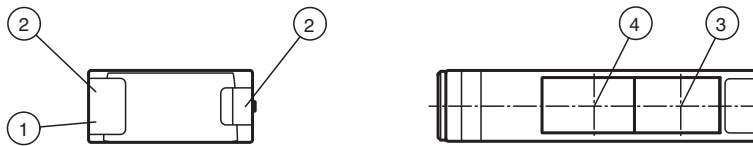

1	Operating display green	3	Optical axis transmitter
2	Function display yellow	4	Optical axis receiver

## Characteristic Curve

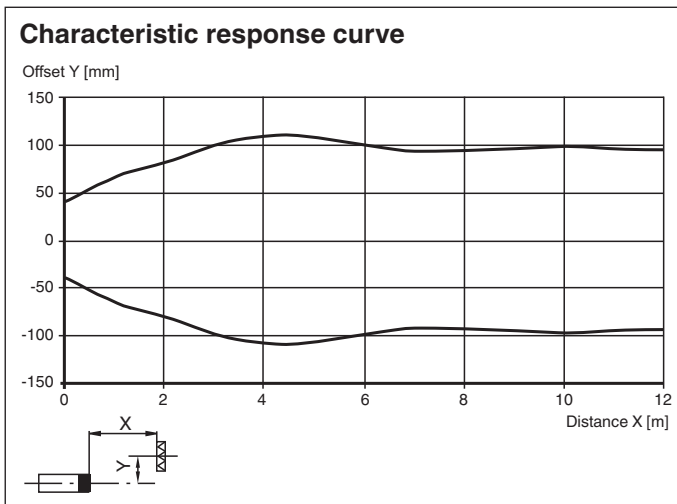

Release date: 2023-03-28 Date of issue: 2023-03-28 Filename: 244371\_eng.pdf

**Characteristic Curve**

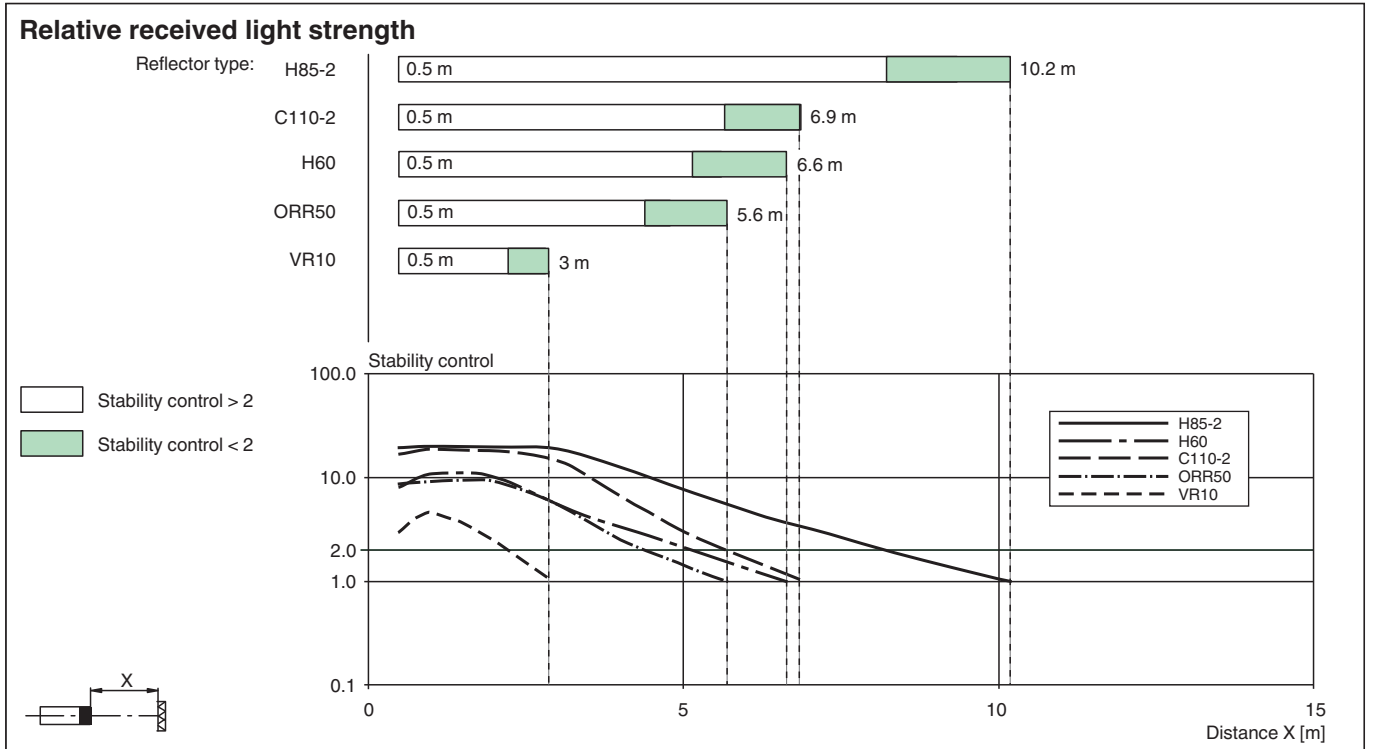

**Accessories**

	<b>OMH-09</b>	Mounting bracket for Sensors series MLV41 for M12 rod mounting
	<b>OMH-40</b>	Mounting bracket
	<b>REF-H85-2</b>	Reflector, rectangular 84.5 mm x 84.5 mm, mounting holes
	<b>REF-H50</b>	Reflector, rectangular 51 mm x 61 mm, mounting holes, fixing strap
	<b>REF-VR10</b>	Reflector, rectangular 60 mm x 19 mm, mounting holes
	<b>ORR50G</b>	Reflector, rectangular 50.9 mm x 60.9 mm, mounting holes, fixing strap and polarization filter
	<b>OFR-100/100</b>	Reflective tape 100 mm x 100 mm

Release date: 2023-03-28 Date of issue: 2023-03-28 Filename: 244371\_eng.pdf