



Valve Connector Cordset VMA-2+P/Z2-1M-PUR-V1-G

- Valve connector according EN 175301-803 A/ISO 4400
- Z diode as a protective circuit
- Built-in LED, as operating and function indicator
- Suitable for drag chains and abrasion resistant
- Moulded seal
- freely selectable cable models due to bridged protective earth
- Flame resistant cable
- Halogen-free
- Oil resistant
- Immunity to vibration

Valve connector Form A, Z-diode LED 2-pin+PE to M12 plug straight A-coded 3-pin, PUR cable black, drag chain suitable



Dimensions

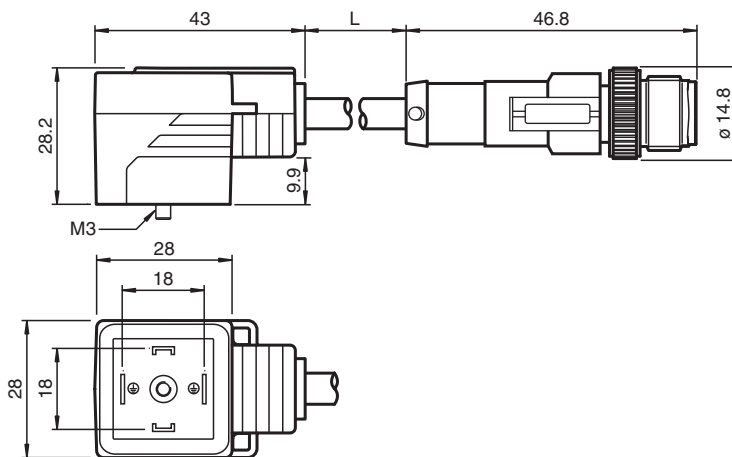

Technical Data

General specifications

Connector 1	
Connection	Valve connector DIN
Construction type	form A
Style	angled
Locking	screw connection
Number of pins	2 + PE
Connector 2	
Connection	plug
Construction type	M12
Style	straight
Locking	screw connection
Number of pins	3
Coding	A-coded
Indicators/operating means	
LED yellow	Operating display

Release date: 2025-02-09 Date of issue: 2025-02-09 Filename: 247709_eng.pdf

Technical Data

Electrical specifications

Operating voltage	U_B	24 V AC/DC
Operating current	I_B	max. 4 A
Suppression		Zener diode

Conformity

Degree of protection		EN 60529
Plug connection		Valve connector : DIN EN 175301-803 connector M12 x 1 : IEC 61076-2-101
Flammability		DIN VDE 0482 , DIN EN 50265-2-1 , UL 94
Halogen-free		DIN VDE 0472-815
UV resistance		DIN EN ISO 4892-2-A
Oil resistance		DIN EN 60811-2-1

Ambient conditions

Ambient temperature		
Connector 1		-20 ... 85 °C (-4 ... 185 °F)
Connector 2		-25 ... 90 °C (-13 ... 194 °F)
Cable, fixed installation		-40 ... 80 °C (-40 ... 176 °F)
Cable, flexing		-20 ... 80 °C (-4 ... 176 °F)
Pollution degree		3

Mechanical specifications

Connector 1		
Tightening torque		0.6 Nm
Tool installation		screw M3 x 29
Mating cycles		min. 100
Connector 2		
Tightening torque		0.6 Nm
Tool installation		straight knurling
Mating cycles		min. 100
Degree of protection		IP65 / IP67
Cable		
Sheath diameter		4.5 mm
Bending radius		> 10 x cable diameter, movable installation > 5 x cable diameter, fixed installation
Sheath color		black (similar to RAL 7021)
Number of cores		3
Core cross section		0.5 mm ²
Cores color		Core 1-4: black Core 2-3: black Core PE-5: green/yellow
Core construction		28 x 0.15 mm Ø
Length	L	1 m
Cable code		Li 9Y 11Y 3 x 0,50
Drag chain suitability		
Drag chain cycles		min. 15000000
Motion velocity		max. 5 m/s
Traverse distance		0.9 m
Acceleration		max. 30 m/s ²
Mass		63 g

Material

Halogen-free		yes
Connector 1		
Body		TPU, black
Seal		TPU , molded
Contact surface		Sn

Technical Data

Flammability	V-0
Connector 2	
Screw connection	Zinc diecast, nickel-plated
Body	TPU, black
Contact surface	Ni/Au
Flammability	HB
Cable	
Sheathing	PUR
Cores	bare copper (Cu)
Core insulation	PP
UV resistance	yes
Oil resistance	good
Flammability	V-0

Connection

