



Universal Temperature Converter KFD2-UT2-2

- 2-channel signal conditioner
- 24 V DC supply (Power Rail)
- Thermocouple, RTD, potentiometer or voltage input
- Usable as signal splitter (1 input and 2 outputs)
- Current output 0/4 mA ... 20 mA
- Sink or source mode
- Configurable by PACTware
- Line fault (LFD) and sensor burnout detection
- Up to SIL 2 acc. to IEC/EN 61508 / IEC/EN 61511

CE SIL2

Function

This signal conditioner provides the galvanic isolation between field circuits and control circuits. The device converts the signal of a resistance thermometer, thermocouple, or potentiometer to a proportional output current. The device can also be configured as a signal splitter. The removable terminal block K-CJC-** is available as an accessory for internal cold junction compensation of thermocouples. A fault is signaled by LEDs acc. to NAMUR NE44 and a separate collective error message output. The device is easily configured by the use of the PACTware configuration software. For additional information, refer to the manual and www.pepperl-fuchs.com.

Connection

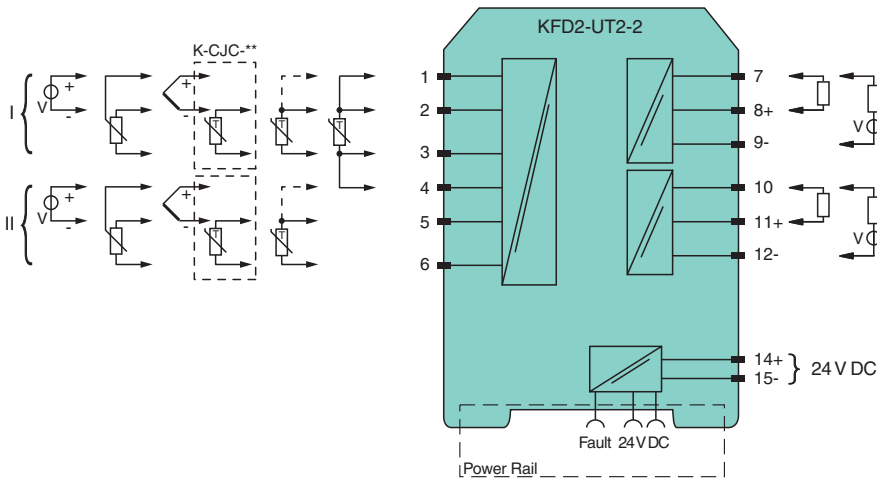

Technical Data

General specifications	
Signal type	Analog input
Functional safety related parameters	
Safety Integrity Level (SIL)	SIL 2
Supply	
Connection	terminals 14+, 15- or power feed module/Power Rail
Rated voltage	U_r 20 ... 30 V DC
Ripple	within the supply tolerance
Power dissipation	≤ 1.53 W
Power consumption	max. 1.53 W

Release date: 2023-01-03 Date of issue: 2023-01-03 Filename: 248761_eng.pdf

Technical Data

Interface	
Programming interface	programming socket
Input	
Connection side	field side
Connection	terminals 1, 2, 3; 4, 5, 6
RTD	type Pt10, Pt50, Pt100, Pt500, Pt1000 (EN 60751: 1995) type Pt10GOST, Pt50GOST, Pt100GOST, Pt500GOST, Pt1000GOST (6651-94) type Cu10, Cu50, Cu100 (P50353-92) type Ni100 (DIN 43760)
Measuring current	approx. 200 µA with RTD
Types of measuring	2-, 3-wire connection
Lead resistance	max. 50 Ω per line
Measurement loop monitoring	sensor breakage, sensor short-circuit
Thermocouples	type B, E, J, K, N, R, S, T (IEC 584-1: 1995) type L (DIN 43710: 1985) type TXK, TXKH, TXA (P8.585-2001)
Cold junction compensation	external and internal
Measurement loop monitoring	sensor breakage
Potentiometer	0 ... 20 kΩ (2-wire connection), 0.8 ... 20 kΩ (3-wire connection)
Voltage	selectable within the range -100 ... 100 mV
Input resistance	≥ 1 MΩ (-100 ... 100 mV)
Output	
Connection side	control side
Connection	output I: terminal 7: source (-), sink (+), terminal 8: source (+), terminal 9: sink(-) output II: terminal 10: source (-), sink (+), terminal 11: source (+), terminal 12: sink(-)
Output I, II	Analog current output
Current range	0 ... 20 mA or 4 ... 20 mA
Fault signal	downscale 0 or 2 mA, upscale 21.5 mA (acc. NAMUR NE43)
Source	load 0 ... 550 Ω open-circuit voltage ≤ 18 V
Sink	Voltage across terminals 5 ... 30 V. If the current is supplied from a source > 16.5 V, series resistance of $\geq (V - 16.5)/0.0215 \Omega$ is needed, where V is the source voltage. The maximum value of the resistance is $(V - 5)/0.0215 \Omega$.
Transfer characteristics	
Deviation	
After calibration	Pt100: $\pm (0.06 \%$ of measurement value in K + 0.1 % of span + 0.1 K (4-wire connection)) thermocouple: $\pm (0.05 \%$ of measurement value in °C + 0.1 % of span + 1 K (1.2 K for types R and S)), includes ± 0.8 K fault of the cold junction compensation (CJC) mV: $\pm (50 \mu\text{V} + 0.1 \%$ of span) potentiometer: $\pm (0.05 \%$ of full scale + 0.1 % of span, (excludes faults due to lead resistance))
Influence of ambient temperature	Pt100: $\pm (0.0015 \%$ of measurement value in K + 0.006 % of span)/K ΔT_{amb}^1 thermocouple: $\pm (0.02 \text{ K} + 0.005 \%$ of measurement value in °C + 0.006 % of span)/K ΔT_{amb}^1 , influence of cold junction compensation (CJC) included mV: $\pm (0.01 \%$ of measurement value + 0.006 % of span)/K ΔT_{amb}^1 potentiometer: $\pm 0.006 \%$ of span/K ΔT_{amb}^1 ¹⁾ ΔT_{amb} = ambient temperature change referenced to 23 °C (296 K)
Influence of supply voltage	< 0.01 % of span
Influence of load	≤ 0.001 % of output value per 100 Ω
Reaction time	worst case value (sensor breakage and/or sensor short circuit detection enabled) mV: 1.2 s, thermocouples with CJC: 1.4 s, thermocouples with fixed ref. temp: 1.4 s, 3- or 4-wire RTD: 1.1 s, 2-wire RTD: 920 ms, Potentiometer: 3-wire connection 2.8 s, 2-wire connection 2.25 s
Galvanic isolation	
Input/Other circuits	basic insulation according to IEC 61010-1, rated insulation voltage 300 V _{eff}
Output/supply, programming input	functional insulation, rated insulation voltage 50 V AC There is no electrical isolation between the programming input and the supply. The programming cable provides galvanic isolation so that ground loops are avoided.
Indicators/settings	
Display elements	LEDs
Configuration	via PACTware
Labeling	space for labeling at the front

Release date: 2023-01-03 Date of issue: 2023-01-03 Filename: 248761_eng.pdf

Technical Data

Directive conformity	
Electromagnetic compatibility	
Directive 2014/30/EU	EN 61326-1:2013 (industrial locations)
Conformity	
Electromagnetic compatibility	
	NE 21:2006
Degree of protection	
	IEC 60529:2001
Ambient conditions	
Ambient temperature	
	-20 ... 60 °C (-4 ... 140 °F)
Mechanical specifications	
Degree of protection	
	IP20
Connection	
	screw terminals
Mass	
	approx. 130 g
Dimensions	
	20 x 119 x 115 mm (0.8 x 4.7 x 4.5 inch) (W x H x D) , housing type B2
Mounting	
	on 35 mm DIN mounting rail acc. to EN 60715:2001
General information	
Supplementary information	Observe the certificates, declarations of conformity, instruction manuals, and manuals where applicable. For information see www.pepperl-fuchs.com .

Assembly

Front view

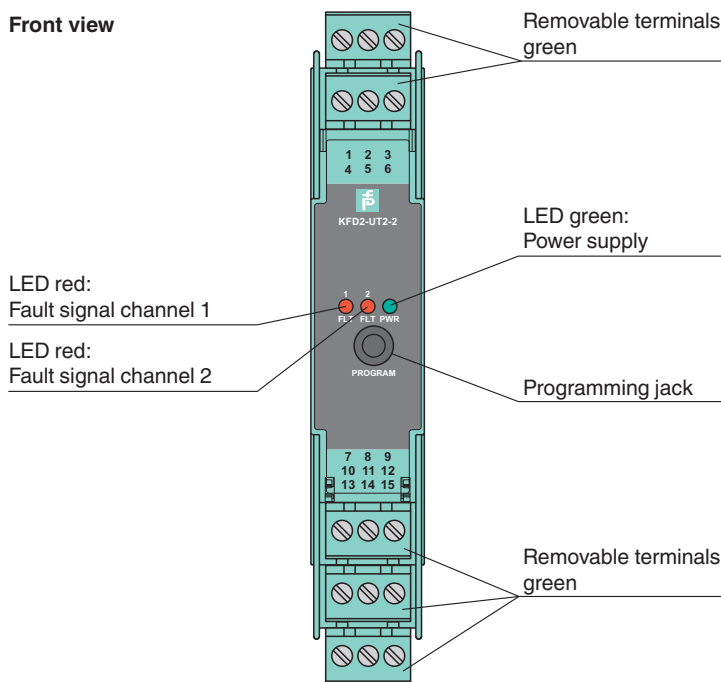







Matching System Components





	DTM Interface Technology	Device type manager (DTM) for interface technology
	PACTware 5.0	FDT Framework
	K-ADP-USB	Programming adapter with USB interface

Release date: 2023-01-03 Date of issue: 2023-01-03 Filename: 248761_eng.pdf

Matching System Components

	KFD2-EB2	Power Feed Module
	UPR-03	Universal Power Rail with end caps and cover, 3 conductors, length: 2 m
	UPR-03-M	Universal Power Rail with end caps and cover, 3 conductors, length: 1,6 m
	UPR-03-S	Universal Power Rail with end caps and cover, 3 conductors, length: 0.8 m
	K-DUCT-GY	Profile rail, wiring comb field side, gray
	K-DUCT-GY-UPR-03	Profile rail with UPR-03-* insert, 3 conductors, wiring comb field side, gray

Accessories

	K-250R	Measuring resistor
	K-500R0%1	Measuring resistor
	K-CJC-BK	Terminal block for cold junction compensation, 3-pin screw terminal, black
	KF-ST-5GN	Terminal block for KF modules, 3-pin screw terminal, green
	KF-CP	Red coding pins, packaging unit: 20 x 6