



# Universal Temperature Converter

## KFD2-UT2-Ex2-1

- 2-channel isolated barrier
- 24 V DC supply (Power Rail)
- Thermocouple, RTD, potentiometer or voltage input
- Usable as signal splitter (1 input and 2 outputs)
- Voltage output 0/1 V ... 5 V
- Configurable by PACTware
- Line fault (LFD) and sensor burnout detection
- Up to SIL 2 acc. to IEC/EN 61508 / IEC/EN 61511



### Function

This isolated barrier is used for intrinsic safety applications. The device converts the signal of a resistance thermometer, thermocouple, or potentiometer to a proportional output voltage. The device can also be configured as a signal splitter. The removable terminal block K-CJC-\*\* is available as an accessory for internal cold junction compensation of thermocouples. A fault is signaled by LEDs acc. to NAMUR NE44 and a separate collective error message output. The device is easily configured by the use of the PACTware configuration software. For additional information, refer to the manual and [www.pepperl-fuchs.com](http://www.pepperl-fuchs.com).

### Connection

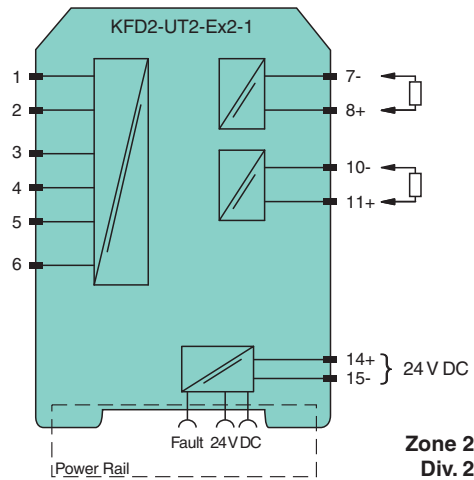
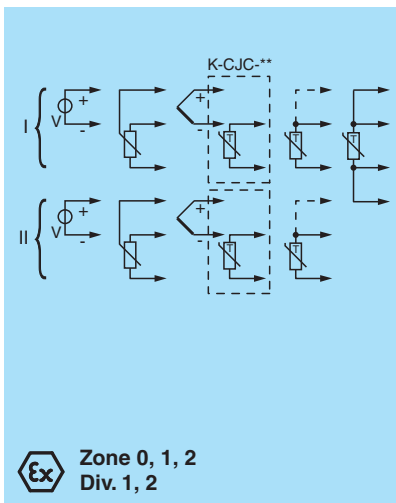

### Technical Data

General specifications	
Signal type	Analog input
Functional safety related parameters	
Safety Integrity Level (SIL)	SIL 2
Supply	
Connection	terminals 14+, 15- or power feed module/Power Rail
Rated voltage	$U_r$ 20 ... 30 V DC
Ripple	within the supply tolerance
Power dissipation	≤ 0.8 W
Power consumption	max. 0.8 W

Release date: 2023-01-03 Date of issue: 2023-01-03 Filename: 248768\_eng.pdf

**Technical Data**

<b>Interface</b>	
Programming interface	programming socket
<b>Input</b>	
Connection side	field side
Connection	terminals 1, 2, 3; 4, 5, 6
RTD	type Pt10, Pt50, Pt100, Pt500, Pt1000 (EN 60751: 1995) type Pt10GOST, Pt50GOST, Pt100GOST, Pt500GOST, Pt1000GOST (6651-94) type Cu10, Cu50, Cu100 (P50353-92) type Ni100 (DIN 43760)
Measuring current	approx. 200 µA with RTD
Types of measuring	2-, 3-wire connection
Lead resistance	max. 50 Ω per line
Measurement loop monitoring	sensor breakage, sensor short-circuit
Thermocouples	type B, E, J, K, N, R, S, T (IEC 584-1: 1995) type L (DIN 43710: 1985) type TXK, TXKH, TXA (P8.585-2001)
Cold junction compensation	external and internal
Measurement loop monitoring	sensor breakage
Potentiometer	0 ... 20 kΩ (2-wire connection), 0.8 ... 20 kΩ (3-wire connection)
Voltage	selectable within the range -100 ... 100 mV
Input resistance	≥ 1 MΩ (-100 ... 100 mV)
<b>Output</b>	
Connection side	control side
Voltage output	0 ... 5 V or 1 ... 5 V ; output resistance: ≤ 5 Ω ; load: ≥ 10 kΩ
Connection	output I: terminals 7-, 8+ output II: terminals 10-, 11+
Fault signal	downscale 0 V or 0.5 V, upscale 5.375 V
<b>Transfer characteristics</b>	
Deviation	
After calibration	Pt100: ± (0.06 % of measurement value in K + 0.1 K (4-wire connection)) thermocouple: ± (0.05 % of measurement value in °C + 1 K (1.2 K for types R and S)) , includes ± 0.8 K fault of the cold junction compensation (CJC) mV: ± 50 µV potentiometer: ± 0.05 % of full scale, (excludes faults due to lead resistance) output: 1 to 5 V output: ± 4 mV from 0 to 103.1 % of span; 0 to 5 V output: ± 4 mV from 0.3 to 102.5 % of span
Influence of ambient temperature	Pt100: ± (0.0015 % of measurement value in K + 0.0075 % of span)/K ΔT <sub>amb</sub> <sup>1)</sup> thermocouple: ± (0.02 K + 0.005 % of measurement value in °C + 0.0075 % of span)/K ΔT <sub>amb</sub> <sup>1)</sup> , influence of cold junction compensation (CJC) included: mV: ± (0.01 % of measurement value + 0.0075 % of span)/K ΔT <sub>amb</sub> <sup>1)</sup> potentiometer: ± 0.0075 % of span/K ΔT <sub>amb</sub> <sup>1)</sup> <sup>1)</sup> ΔT <sub>amb</sub> = ambient temperature change referenced to 23 °C (296 K)
Influence of supply voltage	< 0.01 % of span
Reaction time	worst case value (sensor breakage and/or sensor short circuit detection enabled) mV: 1.2 s, thermocouples with CJC: 1.4 s, thermocouples with fixed ref. temp: 1.4 s, 3- or 4-wire RTD: 1.1 s, 2-wire RTD: 920 ms, Potentiometer: 3-wire connection 2.8 s, 2-wire connection 2.25 s
<b>Galvanic isolation</b>	
Output/supply, programming input	functional insulation, rated insulation voltage 50 V AC There is no electrical isolation between the programming input and the supply. The programming cable provides galvanic isolation so that ground loops are avoided.
<b>Indicators/settings</b>	
Display elements	LEDs
Configuration	via PACTware
Labeling	space for labeling at the front
<b>Directive conformity</b>	
Electromagnetic compatibility	
Directive 2014/30/EU	EN 61326-1:2013 (industrial locations)
<b>Conformity</b>	
Electromagnetic compatibility	NE 21:2006
Degree of protection	IEC 60529:2001

Release date: 2023-01-03 Date of issue: 2023-01-03 Filename: 248768\_eng.pdf

**Technical Data**







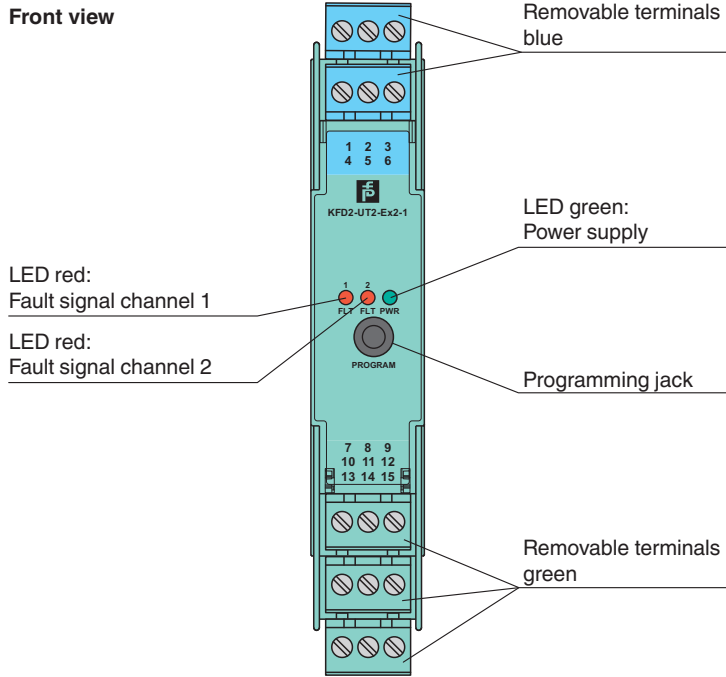

Protection against electrical shock	UL 61010-1:2004	
<b>Ambient conditions</b>		
Ambient temperature	-20 ... 60 °C (-4 ... 140 °F)	
<b>Mechanical specifications</b>		
Degree of protection	IP20	
Connection	screw terminals	
Mass	approx. 130 g	
Dimensions	20 x 119 x 115 mm (0.8 x 4.7 x 4.5 inch) (W x H x D) , housing type B2	
Mounting	on 35 mm DIN mounting rail acc. to EN 60715:2001	
<b>Data for application in connection with hazardous areas</b>		
EU-type examination certificate	CESI 04 ATEX 143	
Marking	Ⓜ II (1)G [Ex ia Ga] IIC Ⓜ II (1)D [Ex ia Da] IIIC Ⓜ I (M1) [Ex ia Ma] I	
Input	Ex ia	
Inputs	terminals 1, 2, 3, 4, 5, 6 (for passive equipment)	
Voltage $U_o$	9 V	
Current $I_o$	22 mA	
Power $P_o$	50 mW	
Analog outputs, power supply, collective error		
Maximum safe voltage	$U_m$	250 V (Attention! This is not the rated voltage.)
Interface		
Maximum safe voltage	$U_m$	250 V (Attention! The rated voltage is lower.), RS 232
Certificate		
Marking	Ⓜ II 3G Ex nA II T4	
Galvanic isolation		
Input/Other circuits	safe electrical isolation acc. to IEC/EN 60079-11, voltage peak value 375 V	
Directive conformity		
Directive 2014/34/EU	EN 60079-0:2012+A11:2013 , EN 60079-11:2012 , EN 60079-15:2010 , EN 50303:2000	
<b>International approvals</b>		
UL approval		
Control drawing	116-0410	
CSA approval		
Control drawing	116-0314 (cCSAus) 116-0347	
IECEX approval		
IECEX certificate	IECEX TUN 07.0003 IECEX CML 16.0126X	
IECEX marking	[Ex ia Ga] IIC , [Ex ia Da] IIIC , [Ex ia Ma] I Ex nA IIC T4 Gc	
<b>General information</b>		
Supplementary information	Observe the certificates, declarations of conformity, instruction manuals, and manuals where applicable. For information see <a href="http://www.pepperl-fuchs.com">www.pepperl-fuchs.com</a> .	

Release date: 2023-01-03 Date of issue: 2023-01-03 Filename: 248768\_eng.pdf

## Assembly



## Matching System Components



	<b>DTM Interface Technology</b>	Device type manager (DTM) for interface technology
	<b>PACTware 5.0</b>	FDT Framework
	<b>K-ADP-USB</b>	Programming adapter with USB interface
	<b>KFD2-EB2</b>	Power Feed Module
	<b>UPR-03</b>	Universal Power Rail with end caps and cover, 3 conductors, length: 2 m
	<b>UPR-03-M</b>	Universal Power Rail with end caps and cover, 3 conductors, length: 1,6 m
	<b>UPR-03-S</b>	Universal Power Rail with end caps and cover, 3 conductors, length: 0.8 m
	<b>K-DUCT-BU</b>	Profile rail, wiring comb field side, blue
	<b>K-DUCT-BU-UPR-03</b>	Profile rail with UPR-03- * insert, 3 conductors, wiring comb field side, blue

## Accessories

	<b>K-CJC-BU</b>	Terminal block for cold junction compensation, 3-pin screw terminal, blue
---	-----------------	---

Release date: 2023-01-03 Date of issue: 2023-01-03 Filename: 248768\_eng.pdf

**Accessories**

	<b>KF-ST-5GN</b>	Terminal block for KF modules, 3-pin screw terminal, green
	<b>KF-ST-5BU</b>	Terminal block for KF modules, 3-pin screw terminal, blue
	<b>KF-CP</b>	Red coding pins, packaging unit: 20 x 6