



## Fiber optic sensor MLV41-LL-IR/95/136



- Robust fiber optic sensor for reliable operation under all conditions
- Adjustable continuous sensitivity
- Easy fiber optic installation with quick-action clamping lock
- Aluminum housing with high-quality Delta Seal coating

Robust fiber optic sensor for glass fiber optics, infrared light, push-pull output, M8 plug



### Function

The unique and extremely popular design of the MLV41 series enables it be mounted correctly in confined areas and offers all the functions that are normally only found on larger phototelectric sensors. The MLV41 series comes with a range of functions. For example, highly visible status LEDs on the front and back, resistance to ambient light, crosstalk protection and universally applicable output stages that permit every possible switching logic and polarity to be realized. The enhanced resistance to ambient light ensures reliable operation even where modern energy-saving lamps with electronic ballasts are in use. The same applies where multiple devices are present, i.e. the use of a number of sensors in the same vicinity causes no problems.

### Dimensions

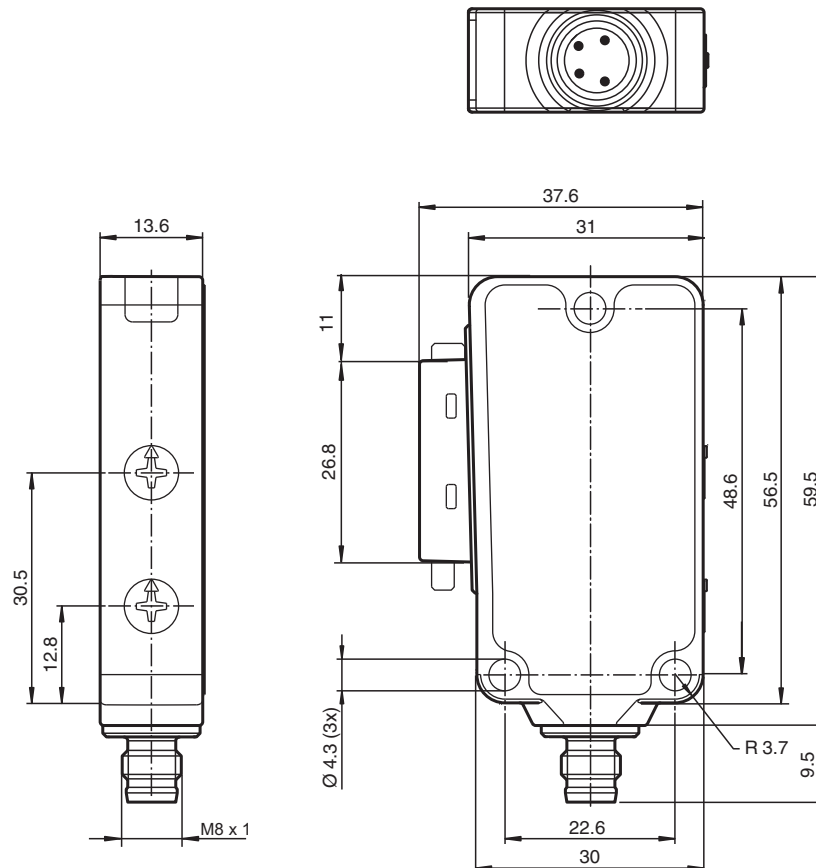

## Technical Data

General specifications		
Sensor range		on black (6 %): up to 55 mm on Kodak white, reflection factor 90% up to 160 mm with LLR 04-1.6-0.5-WC3 fiberoptic cable
Adjustment range		0 ... 160 mm on Kodak white, reflection factor 90%
Reference target		100 mm x 100 mm on Kodak white, reflection factor 90%
Light source		IREDD
Light type		modulated infrared light , 880 nm
Functional safety related parameters		
MTTF <sub>d</sub>		770 a
Mission Time (T <sub>M</sub> )		20 a
Diagnostic Coverage (DC)		0 %
Indicators/operating means		
Operation indicator		LED green, statically lit Power on , Undervoltage indicator: Green LED, pulsing (approx. 0.8 Hz) , short-circuit : LED green flashing (approx. 4 Hz)
Function indicator		LED yellow, lights up with receiver lit ; flashes when falling short of the operating reserve
Control elements		Sensitivity adjuster, light/dark switch
Electrical specifications		
Operating voltage	U <sub>B</sub>	10 ... 30 V DC
Ripple		max. 10 %
No-load supply current	I <sub>0</sub>	max. 40 mA
Output		
Switching type		light/dark on switchable The switching modes specified in the "Electrical Connection" section apply to L/D switches in the "D" position (dark switch)
Signal output		2 push-pull (4 in 1) outputs, complementary, short-circuit proof, reverse polarity protected
Switching voltage		max. 30 V DC
Switching current		max. 100 mA
Voltage drop	U <sub>d</sub>	≤ 2.5 V DC
Switching frequency	f	1000 Hz
Response time		0.5 ms
Conformity		
Product standard		EN 60947-5-2
Approvals and certificates		
UL approval		cULus Listed 57M3 (Only in association with UL Class 2 power supply; Type 1 enclosure)
CCC approval		CCC approval / marking not required for products rated ≤36 V
Ambient conditions		
Ambient temperature		-20 ... 60 °C (-4 ... 140 °F)
Storage temperature		-40 ... 75 °C (-40 ... 167 °F)
Mechanical specifications		
Housing width		31 mm
Housing height		56.5 mm
Housing depth		13.6 mm
Fiber optic adapter		04
Degree of protection		IP67
Connection		M8 x 1 connector, 4-pin
Material		
Housing		Aluminum , Delta-Seal coated
Optical face		Fiber optic connection
Connector		metal
Mass		50 g

## Connection

Option:

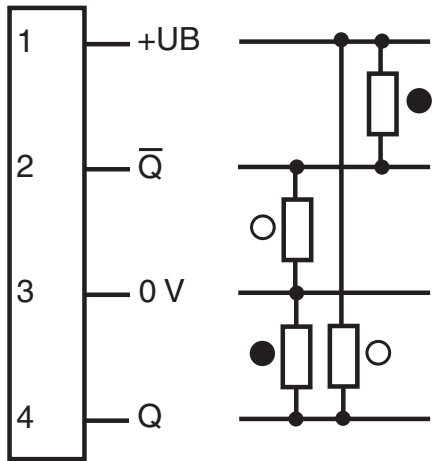

- = Light on
- = Dark on

## Connection Assignment



Wire colors in accordance with EN 60947-5-2

1	BN	(brown)
2	WH	(white)
3	BU	(blue)
4	BK	(black)

## Assembly

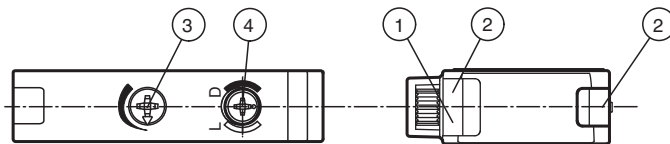









1	Operating display green	3	Sensing range adjuster
2	Function display yellow	4	Bright/dark switch

## Accessories

	<b>V31-WM-2M-PUR</b>	Female cordset single-ended M8 angled A-coded, 4-pin, PUR cable grey
	<b>V31-GM-2M-PUR</b>	Female cordset single-ended M8 straight A-coded, 4-pin, PUR cable grey

Release date: 2023-04-04 Date of issue: 2023-04-04 Filename: 249778\_eng.pdf

## Accessories

	<b>LCR 04-1,6-0,5-Z1</b>	Glass fiber optic - diffuse with PVC covering
	<b>LLR 04-1,6-0,5-G(M6x30)</b>	Glass fiber optic - diffuse with metal silicone covering
	<b>LCR 04-1,6-0,5-WC 3</b>	Glass fiber optic - diffuse with PVC covering
	<b>LLR 04-1,6-0,5-W C3</b>	Glass fiber optic - diffuse with metal silicone covering
	<b>LCE 04-1,6-1,0-Z1</b>	Glass fiber optic - thru-beam with PVC covering
	<b>LCE 04-1,6-1,0 G</b>	Glass fiber optic - thru-beam with PVC covering
	<b>LLE 04-1,6-1,0-G</b>	Glass fiber optic - thru-beam with metal silicone covering
	<b>LCE 04-1,6-1,0-W C3</b>	Glass fiber optic - thru-beam with PVC covering
	<b>LLE 04-1,6-1,0-W C3</b>	Glass fiber optic - thru-beam with metal silicone covering