

Technical Data

General specifications		
Sensor range		on black (6 %): up to 36 mm on Kodak white, reflection factor 90% up to 120 mm with LLR 04-1.6-0.5-WC3 fiberoptic cable
Adjustment range		0 ... 120 mm on Kodak white, reflection factor 90%
Reference target		100 mm x 100 mm on Kodak white, reflection factor 90%
Light source		LED
Light type		modulated visible red light , 660 nm
Functional safety related parameters		
MTTF _d		770 a
Mission Time (T _M)		20 a
Diagnostic Coverage (DC)		0 %
Indicators/operating means		
Operation indicator		LED green, statically lit Power on , Undervoltage indicator: Green LED, pulsing (approx. 0.8 Hz) , short-circuit : LED green flashing (approx. 4 Hz) , IO link communication: green LED goes out briefly (1 Hz)
Function indicator		LED yellow, lights up with receiver lit ; flashes when falling short of the operating reserve
Control elements		sensitivity adjustment
Electrical specifications		
Operating voltage	U _B	10 ... 30 V DC
Ripple		max. 10 %
No-load supply current	I ₀	max. 40 mA
Interface		
Interface type		IO-Link
Protocol		IO-Link V1.0
Mode		COM2 (38.4 kBit/s)
Output		
Switching type		light/dark on
Signal output		2 push-pull (4 in 1) outputs, complementary, short-circuit proof, reverse polarity protected
Switching voltage		max. 30 V DC
Switching current		max. 100 mA
Voltage drop	U _d	≤ 2.5 V DC
Switching frequency	f	1000 Hz
Response time		0.5 ms
Conformity		
Product standard		EN 60947-5-2
Approvals and certificates		
Protection class		II, rated voltage ≤ 50 V AC with pollution degree 1-2 according to IEC 60664-1 functional insulation acc. to DIN EN 50178
UL approval		cULus Listed 57M3 (Only in association with UL Class 2 power supply; Type 1 enclosure)
CCC approval		CCC approval / marking not required for products rated ≤36 V
Ambient conditions		
Ambient temperature		-20 ... 60 °C (-4 ... 140 °F)
Storage temperature		-40 ... 75 °C (-40 ... 167 °F)
Mechanical specifications		
Housing width		31 mm
Housing height		56.5 mm
Housing depth		13.6 mm
Fiber optic adapter		04
Degree of protection		IP67
Connection		2 m fixed cable , 5-pin
Material		

Technical Data

Housing	Aluminum , Delta-Seal coated
Optical face	Fiber optic connection
Mass	50 g

Connection Assignment

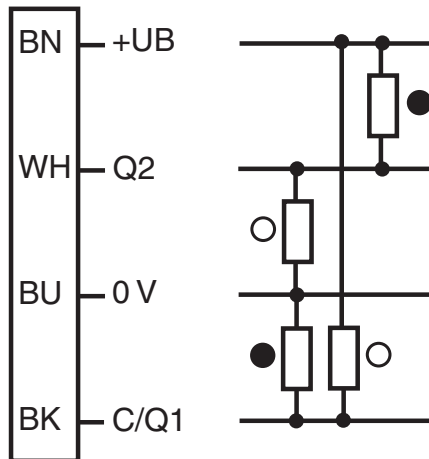

Assembly

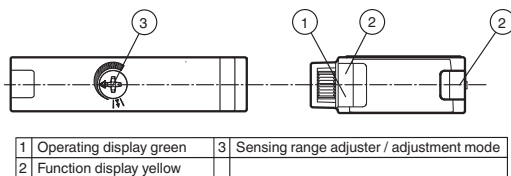







Accessories

	LCR 04-1,6-0,5-Z1	Glass fiber optic - diffuse with PVC covering
	LLR 04-1,6-0,5-G(M6x30)	Glass fiber optic - diffuse with metal silicone covering
	LCR 04-1,6-0,5-WC 3	Glass fiber optic - diffuse with PVC covering
	LLR 04-1,6-0,5-W C3	Glass fiber optic - diffuse with metal silicone covering
	LCE 04-1,6-1,0-Z1	Glass fiber optic - thru-beam with PVC covering
	LCE 04-1,6-1,0 G	Glass fiber optic - thru-beam with PVC covering
	LLE 04-1,6-1,0-G	Glass fiber optic - thru-beam with metal silicone covering

Release date: 2023-04-04 Date of issue: 2023-04-04 Filename: 249790_eng.pdf

Accessories

	LCE 04-1,6-1,0-W C3	Glass fiber optic - thru-beam with PVC covering
	LLE 04-1,6-1,0-W C3	Glass fiber optic - thru-beam with metal silicone covering
	ICE2-8IOL-G65L-V1D	EtherNet/IP IO-Link master with 8 inputs/outputs
	ICE3-8IOL-G65L-V1D	PROFINET IO IO-Link master with 8 inputs/outputs
	ICE1-8IOL-G30L-V1D	Ethernet IO-Link module with 8 inputs/outputs
	ICE1-8IOL-G60L-V1D	Ethernet IO-Link module with 8 inputs/outputs
	ICE2-8IOL-K45P-RJ45	EtherNet/IP IO-Link master with 8 inputs/outputs, DIN rail, push-in connectors
	ICE2-8IOL-K45S-RJ45	EtherNet/IP IO-Link master with 8 inputs/outputs, DIN rail, screw terminal
	ICE3-8IOL-K45P-RJ45	PROFINET IO IO-Link master with 8 inputs/outputs, DIN rail, push-in terminals
	ICE3-8IOL-K45S-RJ45	PROFINET IO IO-Link master with 8 inputs/outputs, DIN rail, screw terminal
	IO-Link-Master02-USB	IO-Link master, supply via USB port or separate power supply, LED indicators, M12 plug for sensor connection

IO link function

The IO link operating mode is indicated by the green LED indicator with a short interruption ($f = 1 \text{ Hz}$). IO link communication simultaneously provides process data (measurement data from the sensor) and access to requirement data.

The requirement data contains the following information:

Identification:

- Manufacturer information
- Product ID
- User-specific ID

Device parameters:

- Teach-in parameters
- Operating parameters
- Configuration parameters
- Device commands

Diagnostic messages and warnings

Setting information

Detection range adjustment:

The detection range can be set via the rotary switch or the IO-Link.

Setting using the rotary switch:

If you would like to change the detection range on the sensor, turn:

- the rotary switch to the left to reduce the value.
- the rotary switch to the right to increase the value.

With the IO-Link, the set detection range the current rotary switch configuration is always assigned.

If the rotary switch is too far to the left or the right, perform the following:

Turn the potentiometer completely to the left until it stops. The LED will briefly flash green.

The assignment of the current rotary switch configuration to the detection range set via IO-Link is overridden.

Now set the desired detection range again.

Example application - manually reduce detection range:



The potentiometer has one position as shown here. The adjustable detection range is set via IO-Link to maximum. The rotary switch is too far to the left to set a considerably lower detection range for example.



Turn the potentiometer to the left until it stops to override the set value to this rotary switch configuration. The LED will briefly flash green.



Now set the desired detection range again.