



Light grid

LGM17



- Measuring automation light grid with switching output
- Optical resolution 17 mm
- Super-fast object detection, even with 3-way beam crossover
- Object identification using integrated object recognition
- IO-Link interface for service and process data
- Temperature range to -30 °C
- Output of a measured value, can be selected from a number of measuring functions

Measuring automation light grid with beam spacing of 17 mm, IO-Link interface, push-pull output, fixed cable with M12 plug



IO-Link

Function

Automation light grids in the LGM Series are designed to measure small to large objects. The slimline light grids are modular in design and are available with various beam gaps and field heights. The entire signal evaluation process is carried out within the device. The lightweight systems can be integrated elegantly into their surroundings, from both a technical and a visual perspective. As a result, machines and plants operating in temperature ranges between -30 °C ... +60 °C can be designed to more compact dimensions.

Application

- Detection of objects over large areas
- Detecting and counting irregular objects
- Measuring and sorting objects of different heights (height checking)
- Presence and overhang control in material handling systems
- Web sag monitoring
- Position or shape monitoring (object identification)

Dimensions

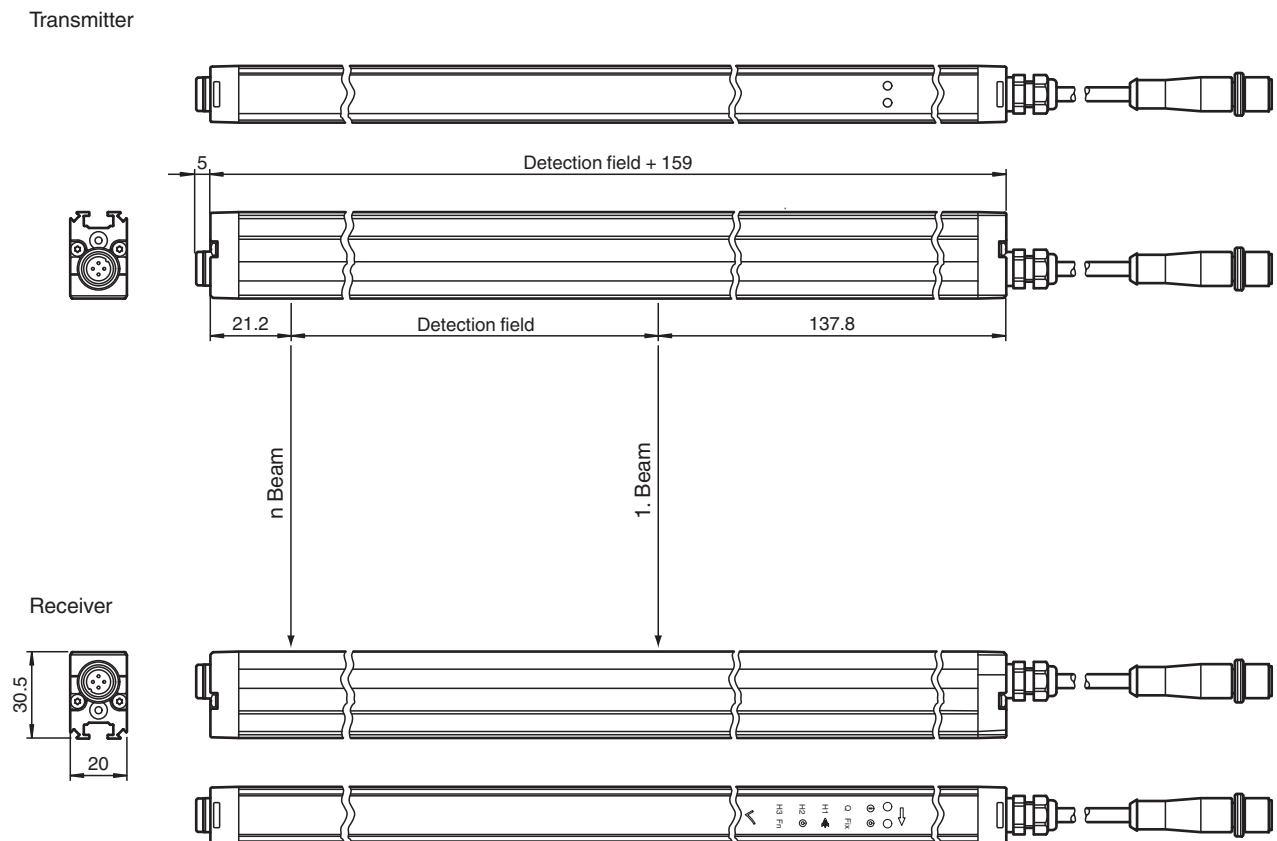

Technical Data

General specifications

Effective detection range	Standard : 0.3 ... 6 m
Threshold detection range	7.5 m
Light source	IRED
Light type	modulated infrared light , 850 nm
Field height	see Table 1, max. 3200 mm
Beam crossover	Factory setting: three beam crossing, deactivateable
Beam blanking	adjustable max. 2 fixed suppressible beam areas (blanking)
Beam spacing	16.67 mm
Number of beams	see Table 1, max. 193
Operating mode	Emitter: Emitter power adjustable in two ranges
Optical resolution	without beam crossover: 17 mm with beam crossover: 8.5 mm with in 25% and 75% of the range
Opening angle	10 °
Ambient light limit	> 50000 Lux (if external light source is outside the opening angle)

Functional safety related parameters

MTTF _d	25 a
Mission Time (T _M)	20 a
Diagnostic Coverage (DC)	60 %

Indicators/operating means

Technical Data

Operation indicator		LED green: constantly on - power-on double pulse flashing (0.8 Hz) - undervoltage flashing (4 Hz) - short circuit flashing with short interruptions (1 Hz) - IO-Link mode
Status indicator		Emitter: LED yellow constantly on - high emitter power constantly off - low emitter power flashing (8 Hz) - error message Receiver: LED yellow: constantly on - object detected constantly off - no object detected flashing (4 Hz) - below stability control limit flashing (8 Hz) - error message
Control elements		Receiver: 2 touch buttons for programming
Electrical specifications		
Operating voltage	U_B	18 ... 30 V DC
Ripple		10 %
No-load supply current	I_0	Emitter \leq 50 mA Receiver: \leq 150 mA (without outputs)
Time delay before availability	t_v	see Table 1, max. 3 s
Interface		
Interface type		IO-Link (pin 4)
IO-Link revision		1.0
Device ID		1050369 ... 1050400 (0x100701 ... 0x100720)
COM-Mode		COM2 (38.4 kBit/s)
Min. cycle time		2.3 ms
Process data width		16 bit
SIO mode support		yes
Input		
Test input		Emitter switch-off with +UB or 0 V at pin 4 (emitter)
Function input		Range input activation from 1.6 m with +UB or 0 V on pin 2 (emitter) Teach-In input for parameterization on pin 8 (receiver)
Output		
Stability alarm output		Stability Control (SC) 1 PNP, short-circuit protected, reverse polarity protected on pin 2 (receiver)
Switching type		Factory setting: dark on , Switchable to light-on mode
Signal output		Command interface: Pin 4 IO-Link interface C or used as switching output Q; 1 short-circuit proof reverse polarity protected push-pull output (receiver) Switch output: Pin 5 switching output Q; 1 short-circuit proof reverse polarity protected push-pull output (receiver) synchronized with pin 4
Switching threshold		Factory setting: The signal tracking for the threshold value is deactivated, increasing the optical resolution by a maximum of 4 mm; switchable to active signal tracking
Switching voltage		max. 30 V DC
Switching current		max. 100 mA
Voltage drop	U_d	\leq 2 V DC
Switching frequency	f	see Table 1, max. 129 Hz
Response time		see Table 1, max. 16 ms
Timer function		Off-delay programmable from 0 ... 1.25 s in 5 ms steps (adjustment via IO-Link only)
Conformity		
Communication interface		IEC 61131-9
Product standard		EN 60947-5-2
Approvals and certificates		
Protection class		III (IEC 61140)
UL approval		cULus Listed
CCC approval		CCC approval / marking not required for products rated \leq 36 V
Ambient conditions		
Ambient temperature		-30 ... 60 °C (-22 ... 140 °F)
Storage temperature		-30 ... 70 °C (-22 ... 158 °F)
Mechanical specifications		

Technical Data

Conductor cross section	min. 0.25 mm ²
Housing width	20 mm
Housing depth	30.5 mm
Housing length L	see Table 1, max. 3360 mm
Degree of protection	IP67
Connection	Emitter: connecting cable with 4-pin, M12 x 1 connector , 330 mm total length Receiver: connecting cable with 8-pin, M12 x 1 connector , 350 mm total length
Material	
Housing	extruded aluminum section , Silver anodized
Optical face	Plastic pane , Polycarbonate
Mass	see Table 1, max. 1750 g (per profile)
Cable length	max. 30 m

Connection Assignment

Transmitter

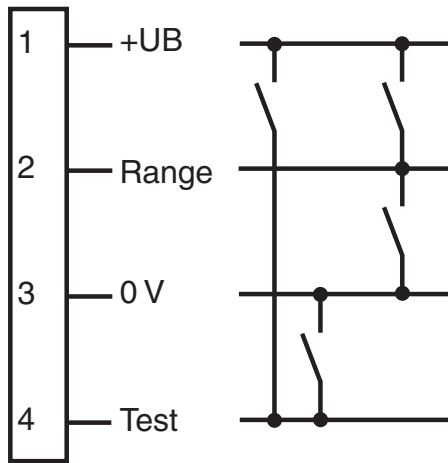

Receiver

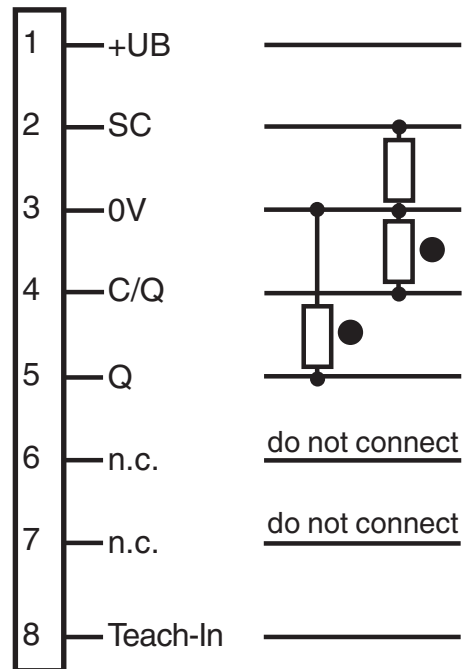

Connection Assignment

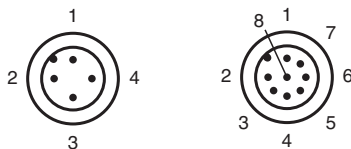

Release date: 2023-04-04 Date of issue: 2023-04-04 Filename: 251332_eng.pdf

Assembly

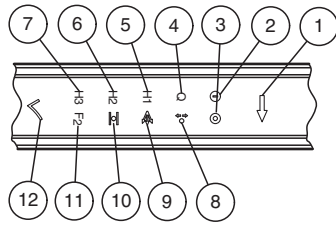

1	Menu button	yellow	7	not used	yellow
2	Operating indicator	green	8	Object floating	yellow
3	Status display	yellow	9	Crossing	yellow
4	Q object	yellow	10	Peripheral beam tolerance	yellow
5	not used	yellow	11	2nd level	yellow
6	not used	yellow	12	OK button	yellow

2nd level: Beam collimation, inverse mode, light-on/dark-on switching, reset factory setting, signal tracking

Characteristic Curve

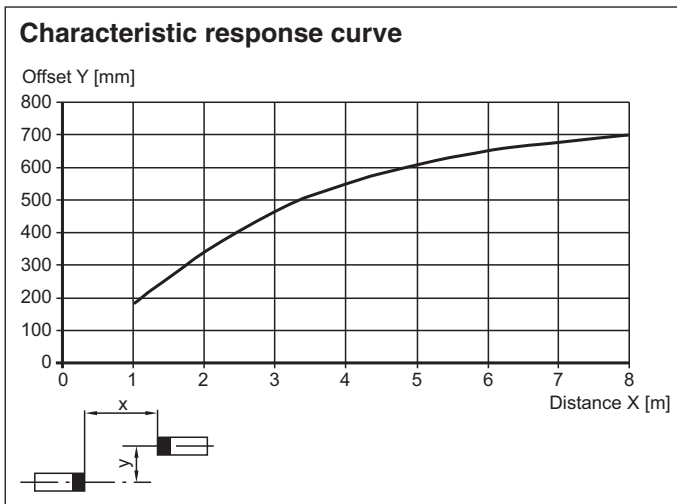

System Description

The light grid consists of a emitter and a receiver, between which is the area to be monitored.

The switching command and measurement of the object is triggered when an object enters or is already present in the monitoring field.

The modular system design supports a wide range of distances for the lines of light. Optimum implementation of the light grids for specific application requirements is thus possible.

The system is programmed using the integrated touch field or the IO-Link interface.

Output of the analog measured value is included in the IO-Link protocol. Users can choose from a vast selection of integrated measurement protocols.

The most important measurement protocols are:











- Lowest position of the object
- Highest position of the object
- Height of the object
- Height of the object as the total height of all partial objects
- Height of the largest partial object
- Mid-position of the largest partial object
- Lowest position of the largest partial object
- Highest position of the largest partial object
- ...

Parameterization







IO-Link

The sensor parameters are device-specific and are described in the standardized IO Device Description file (IODD). The IODD can be read into different engineering tools using IODD support from different system providers. The sensor can then be configured or diagnosed using the relevant tool and a user interface generated from the IODD. The IODD interpreter are available in the corresponding product description on our homepage, www.pepperl-fuchs.com. For the IODD description contact the Pepperl+Fuchs support.

Accessories

	V19-G-EMV-BK0,3M-PVC-V19-G	Double-ended cordset, M12 to M12, with EMC filter, 8-pin, PVC cable
	OMH-SLCT-01	Quick clamp and adjustment system
	OMH-SLCT-06	Swivel Bracket
	OMH-LGS-01	Attachment aid for light grid series LGS/LGM
	OMH-SLCT-03	Mounting bracket including adjustment
	OMH-SLCT-04	Mounting bracket including adjustment (with loose bearing)
	OMH-SLCT-05	Mounting bracket including adjustment
	AA SLCT-01	Profile alignment aid; simplified alignment of the SLCS and SLCT safety light curtains
	V1-G-BK2M-PUR-U	Female cordset single-ended M12 straight A-coded, 4-pin, PUR cable black, UL approved, drag chain suitable, torsion resistant
	V1-G-BK5M-PUR-U	Female cordset single-ended M12 straight A-coded, 4-pin, PUR cable black, UL approved, drag chain suitable, torsion resistant
	V1-G-BK10M-PUR-U	Female cordset single-ended M12 straight A-coded, 4-pin, PUR cable black, UL approved, drag chain suitable, torsion resistant
	V1-G-BK15M-PUR-U	Female cordset single-ended M12 straight A-coded, 4-pin, PUR cable black, UL approved, drag chain suitable, torsion resistant
	V19-G-BK10M-PUR-IEC	Female cordset, M12, 8-pin, PUR-cable
	V19-G-BK2M-PUR-IEC	Female cordset, M12, 8-pin, PUR-cable
	V19-G-BK5M-PUR-IEC	Female cordset, M12, 8-pin, PUR-cable
	V19-G-BK2M-PUR-U-V1-G	Cordset M12 socket straight A-coded 8-pin to M12 plug straight A-coded 4-pin, PUR cable black, UL approved, drag chain suitable, torsion resistant
	PACTware 4.1	FDT Framework
	V1-G-BK0,6M-PUR-U-V1-G-LGS25T	Cordset, LGS25 light grids to ICE modules/WIS 2, M12 to M12, PUR cable, 4-pin
	ICE2-8IOL-G65L-V1D	EtherNet/IP IO-Link master with 8 inputs/outputs
	ICE3-8IOL-G65L-V1D	PROFINET IO IO-Link master with 8 inputs/outputs

Accessories

	ICE1-8IOL-G30L-V1D	Ethernet IO-Link module with 8 inputs/outputs
	ICE1-8IOL-G60L-V1D	Ethernet IO-Link module with 8 inputs/outputs
	ICE2-8IOL-K45P-RJ45	EtherNet/IP IO-Link master with 8 inputs/outputs, DIN rail, push-in connectors
	ICE2-8IOL-K45S-RJ45	EtherNet/IP IO-Link master with 8 inputs/outputs, DIN rail, screw terminal
	ICE3-8IOL-K45P-RJ45	PROFINET IO IO-Link master with 8 inputs/outputs, DIN rail, push-in terminals
	ICE3-8IOL-K45S-RJ45	PROFINET IO IO-Link master with 8 inputs/outputs, DIN rail, screw terminal
	IO-Link-Master02-USB	IO-Link master, supply via USB port or separate power supply, LED indicators, M12 plug for sensor connection

Technical Features

Table 1:

Switch-on delay, maximum switching frequency, and maximum time delay before availability:

Field height [mm]	Switch-on delay Q [ms] Without object parameterization		Switch-on delay Q [ms] - With object parameterization - Updated measured value		Maximum switching frequency [Hz]	Maximum time delay before availability tv [s]
	typ.	max.	typ.	max.		
100	3	4	5	7	129	0.8
200	3	5	5	7	118	0.9
300	3	5	6	8	109	1.0
400	3	5	6	9	101	1.0
500	3	6	6	10	94	1.1
600	3	6	7	10	88	1.2
700	4	7	7	11	82	1.3
800	4	7	7	12	78	1.3
900	4	7	8	13	73	1.4
1000	4	8	8	13	70	1.5
1100	4	8	9	14	66	1.5
1200	5	8	9	15	63	1.6
1300	5	9	9	16	60	1.7
1400	5	9	10	16	58	1.8
1500	5	10	10	17	56	1.8
1600	5	10	10	18	53	1.9
1700	6	10	11	19	51	2.0
1800	6	11	11	19	49	2.0
1900	6	11	12	20	48	2.1
2000	6	11	12	21	46	2.2
2100	6	12	12	22	45	2.3
2200	6	12	13	22	43	2.3
2300	7	13	13	23	42	2.4
2400	7	13	13	24	41	2.5
2500	7	13	14	25	40	2.5
2600	7	14	14	25	38	2.6
2700	7	14	15	26	37	2.7
2800	8	14	15	27	36	2.8
2900	8	15	15	27	35	2.8
3000	8	15	16	28	35	2.9
3100	8	16	16	29	34	3.0
3200	8	16	16	30	33	3.0

Number of beams, housing length, and weight:

Field height [mm]	Number of beams	Overall length of the transmitter/receiver unit [mm]	Weight of transmitter/receiver unit [g]
100	7	260	200
200	13	360	250

Release date: 2023-04-04 Date of issue: 2023-04-04 Filename: 251332_eng.pdf

Field height [mm]	Number of beams	Overall length of the transmitter/receiver unit [mm]	Weight of transmitter/receiver unit [g]
300	19	460	300
400	25	560	350
500	31	660	400
600	37	760	450
700	43	860	500
800	49	960	550
900	55	1060	600
1000	61	1160	650
1100	67	1260	700
1200	73	1360	750
1300	79	1460	800
1400	85	1560	850
1500	91	1660	900
1600	97	1760	950
1700	103	1860	1000
1800	109	1960	1050
1900	115	2060	1100
2000	121	2160	1150
2100	127	2260	1200
2200	133	2360	1250
2300	139	2460	1300
2400	145	2560	1350
2500	151	2660	1400
2600	157	2760	1450
2700	163	2860	1500
2800	169	2960	1550
2900	175	3060	1600
3000	181	3160	1650
3100	187	3260	1700
3200	193	3360	1750

Design and Function

Safety information

The device must be operated only at low protective voltage where there is safe electrical isolation. Modifications and repairs must be carried out only by your supplier!

The system must be maintained and inspected on a regular basis.

A soft, clean cloth may be used to clean the system. Do not use any aggressive or abrasive cleaning agents that will corrode the surfaces. The device must not be subjected to severe impacts or vibrations.

Commissioning

Prerequisites

- The transmitter unit and receiver unit have been mounted and aligned correctly.
- The electrical connection has been established as per the information in the connection diagram.
- The signal output responds to object measurement.
- If at least one beam of light is interrupted, the output remains active for as long as the object is detected.

Troubleshooting

- Measure operating voltage
- Check cabling.
- Check transmitter and receiver unit for dirt. Clean if necessary.

Function indicators

A green LED for indicating the operating status "Power ON" and a yellow status indication LED are fitted on the connection side of the profiles, behind the lens cover.

Transmitter Unit

Function	Description of Diagnosis
Green LED to display operating status permanently illuminated	Power On
Green LED to display operating status is not illuminated. Yellow LED to indicate status is flashing	Energy-saving mode
Yellow LED to indicate status is not illuminated	Transmission power of transmitter is low
Yellow LED to indicate status is permanently illuminated	Transmission power of transmitter is high
Yellow LED to indicate status is flashing rapidly (approx. 8 Hz)	Fault state
Yellow LED to indicate status — brief change in light emitted	Test input is activated

Receiver Unit

Function	Description of Diagnosis
Green LED to display operating status permanently illuminated	Power On
Green LED to display operating status is not illuminated	Energy-saving mode
Green LED to display operating status is flashing at brief intervals	IO-Link mode active. Possible to parameterize the device only via IO-Link
Green LED to display operating status is flashing (4 Hz)	Fault status: short circuit at the outputs
Yellow LED to indicate status is permanently illuminated	Detection field interrupted
Yellow LED to indicate status is not illuminated	Detection field is clear.
Yellow LED to indicate status is flashing (approx. 4 Hz)	Insufficient stability control
Yellow LED to indicate status is flashing rapidly (approx. 8 Hz)	Fault state: fault during signal measurement

Resolution and Beam Gap

The optical resolution of the light grid corresponds to the size of the object that can be detected.

The values specified in the technical data under "Optical Resolution" apply if signal tracking for the threshold value is activated. Where the system is parameterized via the touch field menu (level 2, "Signal Tracking"), the value is automatically set to 60 %. It is not possible to set other values. To parameterize the system via IO-Link, a threshold value of at least 60 % must be entered. Signal tracking for the threshold value is deactivated by default, increasing the optical resolution by a maximum of 4 mm. By selecting 3-way crossover of the light beams, the resolution of the light grid is refined.

The switching outputs respond to any instance in which the beam is interrupted by an object. Selective object detection can also be parameterized using predefined or taught-in objects. Up to 2 beam areas can be suppressed (blinking).

The devices are supplied without object detection programmed, with signal tracking of the threshold value deactivated, and with a beam path with a 3-way crossover.

Resolution of the Crossed Beam Arrangement

If 3-way beam crossover is programmed, the resolution is refined. In the case of 3-way crossover, this means that the increased resolution is offered once 25 % of the transmitter unit range or receiver unit range has been covered. It is therefore necessary to ensure that all objects pass the transmitter or receiver with such a gap.

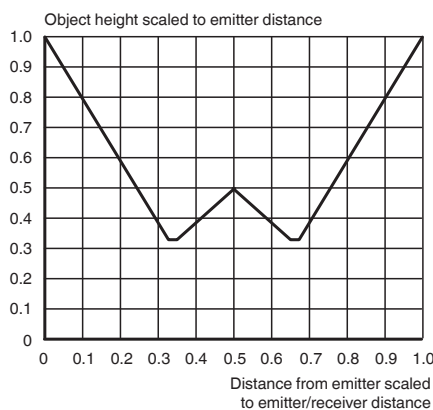

Release date: 2023-04-04 Date of issue: 2023-04-04 Filename: 2511332_eng.pdf

Type Code



Resolution [mm]
(see technical data)

Detection field [mm]
(see technical data)

IO-Link interface

Options

- /110 Push-pull output, switch output 0.1 A, short-circuit protected, reverse polarity protection
- /115b with 0.2 m fixed cable and M12 connector