

Accessories

DoorScan Profile L3000 5pcs



- Aluminum profile for DoorScan Series
- Length 3000 mm
- for DoorScan design with great profil length

Housing profile DoorScan

Dimensions

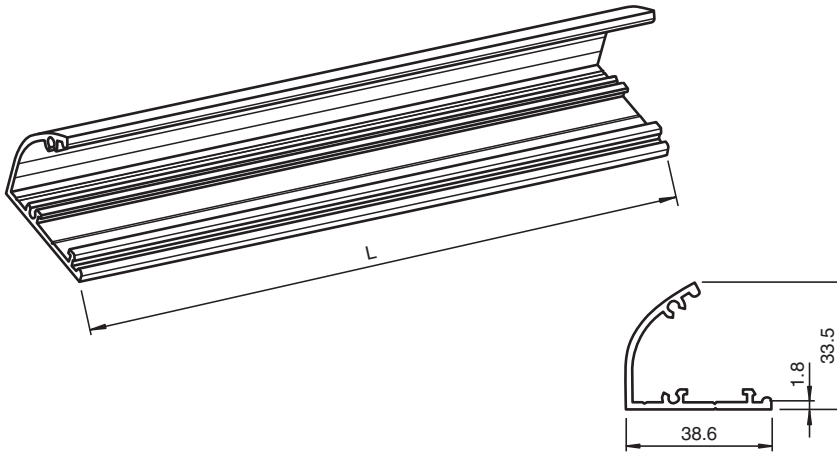

Technical Data

Ambient conditions

Ambient temperature -30 ... 60 °C (-22 ... 140 °F)

Mechanical specifications



Housing length L 3000 mm

Material aluminum

Suitable series







Series DoorScan®, TopScan-S

Accessories

| | | |
|---|-------------------------------------|--|
|  | DoorScan Weather Cap L1200 | All-weather hood for DoorScan® and TopScan series sensing strips |
|  | DoorScan Transfer Loop | Door transition cable to door controller for DoorScan® sensor, including cable sheathing and strain relief |
|  | DoorScan Connection Cable 5p | Connecting cable with 5 plug-in connections for DoorScan®-I/-T/-R modules |

Release date: 2020-03-24 Date of issue: 2020-10-08 Filename: 251780_eng.pdf

Accessories

| | | |
|---|--------------------------------|--|
|  | DoorScan Cable BS/BGS | Connecting cable for transition from hinge side to leading edge side |
|  | DoorScan End Caps | End cap set for DoorScan® sensor profile |
|  | TopScan-S Profile L1400 | Housing profile TopScan-S |
|  | TopScan-S Cover L1400 | Housing cover TopScan-S |
|  | DoorScan Relay Module | Replacement/extension sensor module for installation in the DoorScan® and TopScan sensor profile, multifunction interface module |
|  | DoorScan Adapter | Adapter module for installation in the DoorScan® and TopScan sensor profile, multifunction interface module |