

# Cable socket, shielded V19-W-30M-PUR-ABG

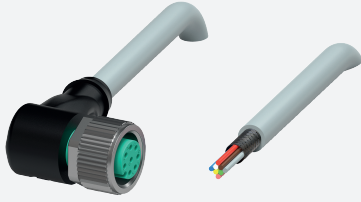

- Degree of protection IP68 / IP69
- Halogen-free
- Shield connected to screw connection
- Specific design protects against loosening and inaccurate installation

Female cordset single-ended M12 angled A-coded, 8-pin, PUR cable grey, shielded



## Dimensions

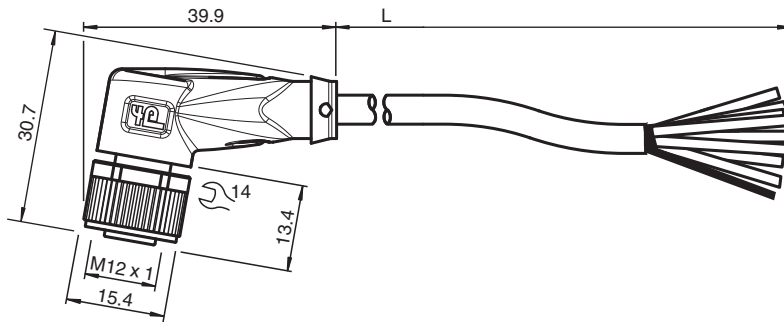

## Technical Data

### General specifications

Connector 1		
Connection		socket
Construction type		M12
Style		angled
Locking		screw connection
Number of pins		8
Coding		A-coded
Connector 2		
Connection		cable end

### Electrical specifications

Operating voltage	$U_B$	max. 30 V AC/DC
Operating current	$I_B$	max. 2 A

### Conformity

Degree of protection		EN 60529
Plug connection		connector M12 x 1 : IEC 61076-2-101

Release date: 2022-11-30 Date of issue: 2022-12-01 Filename: 251797\_eng.pdf





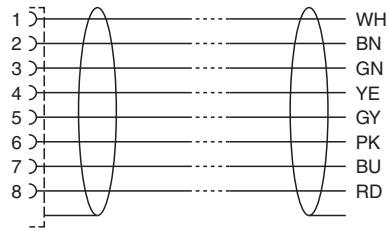
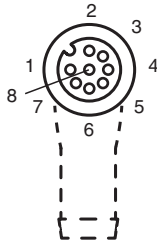

## Technical Data

Halogen-free		DIN VDE 0472-815 DIN EN 50267-2-1
<b>Ambient conditions</b>		
Ambient temperature		
Plug connector		-40 ... 90 °C (-40 ... 194 °F)
Cable, fixed		-40 ... 80 °C (-40 ... 176 °F)
Cable, flexing		-20 ... 80 °C (-4 ... 176 °F)
Pollution degree		3
<b>Mechanical specifications</b>		
Plug connector		
Tightening torque		0.6 Nm
Loosening protection		available
Tool installation		straight knurling and hexagon nut SW = 14 mm
Mating cycles		min. 100
Shielding		shield connected to screw connection
Degree of protection		IP68 / IP69
Cable		according to IEC/EN 60228 (DIN VDE 0295) class 5
Sheath diameter		6 mm
Bending radius		> 10 x cable diameter, moving > 5 x cable diameter, fixed
Sheath stripping force		max. 100 N / 300 mm
Sheath color		grey (similar to RAL 7001)
Number of cores		8
Core cross section		0.25 mm <sup>2</sup>
Cores color		Core 1: white Core 2: brown Core 3: green Core 4: yellow Core 5: grey Core 6: pink Core 7: blue Core 8: red
Core construction		14 x 0.15 mm Ø
Shield		tinned copper braiding, 85 % coverage
Length	L	30 m
Cable code		Li 9Y V1 C V1 11Y 8 x 0,25
<b>Material</b>		
Halogen-free		yes
Plug connector		
Screw connection		Zinc diecast, nickel-plated
Body		TPU, black
Seal		FKM
Contact surface		gold plated (Au)
Flammability		V-2
Cable		
Sheathing		PUR based on polyether
Core insulation		PP
Chemical resistance		good

## Connection Assignment



## Accessories

	<b>MH V1-SCREWDRIVER</b>	Torque screwdriver (0.6 Nm)
	<b>MH V1-BIT M12</b>	plug-in cap M12
	<b>V1/V3-LABELHOLDER</b>	Label holder
	<b>V1/V3-LABEL</b>	Label plate
	<b>MH V1-Holder</b>	Modular universal holder for M12 connectors
	<b>V1-CLIP</b>	Unlocking protector for M12 connector
	<b>V1-MARKING-RING-COLOR</b>	Marking rings for M12 connectors, various colors