

Cable socket, shielded V19-W-40M-PUR-ABG

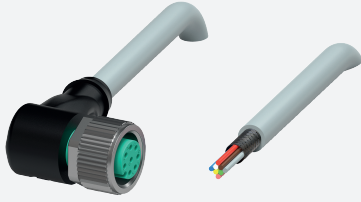

- Degree of protection IP68 / IP69
- Halogen-free
- Shield connected to screw connection
- Specific design protects against loosening and inaccurate installation

Female cordset single-ended M12 angled A-coded, 8-pin, PUR cable grey, shielded



Dimensions

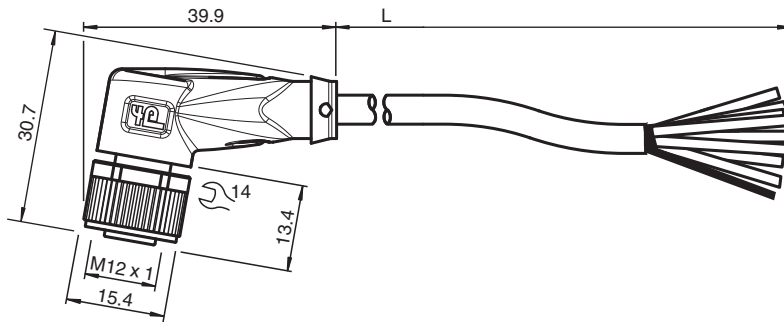

Technical Data

General specifications

| | | |
|-------------------|--|------------------|
| Connector 1 | | |
| Connection | | socket |
| Construction type | | M12 |
| Style | | angled |
| Locking | | screw connection |
| Number of pins | | 8 |
| Coding | | A-coded |
| Connector 2 | | |
| Connection | | cable end |

Electrical specifications

| | | |
|-------------------|-------|-----------------|
| Operating voltage | U_B | max. 30 V AC/DC |
| Operating current | I_B | max. 2 A |

Conformity

| | | |
|----------------------|--|-------------------------------------|
| Degree of protection | | EN 60529 |
| Plug connection | | connector M12 x 1 : IEC 61076-2-101 |

Release date: 2022-11-30 Date of issue: 2022-12-01 Filename: 251798_eng.pdf





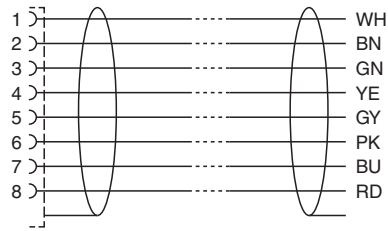
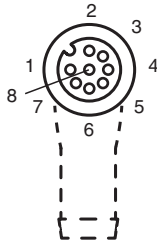

Technical Data

| | | |
|----------------------------------|---|--|
| Halogen-free | | DIN VDE 0472-815 DIN EN 50267-2-1 |
| Ambient conditions | | |
| Ambient temperature | | |
| Plug connector | | -40 ... 90 °C (-40 ... 194 °F) |
| Cable, fixed | | -40 ... 80 °C (-40 ... 176 °F) |
| Cable, flexing | | -20 ... 80 °C (-4 ... 176 °F) |
| Pollution degree | | 3 |
| Mechanical specifications | | |
| Plug connector | | |
| Tightening torque | | 0.6 Nm |
| Loosening protection | | available |
| Tool installation | | straight knurling and hexagon nut SW = 14 mm |
| Mating cycles | | min. 100 |
| Shielding | | shield connected to screw connection |
| Degree of protection | | IP68 / IP69 |
| Cable | | according to IEC/EN 60228 (DIN VDE 0295) class 5 |
| Sheath diameter | | 6 mm |
| Bending radius | | > 10 x cable diameter, moving > 5 x cable diameter, fixed |
| Sheath stripping force | | max. 100 N / 300 mm |
| Sheath color | | grey (similar to RAL 7001) |
| Number of cores | | 8 |
| Core cross section | | 0.25 mm ² |
| Cores color | | Core 1: white Core 2: brown Core 3: green Core 4: yellow Core 5: grey Core 6: pink Core 7: blue Core 8: red |
| Core construction | | 14 x 0.15 mm Ø |
| Shield | | tinned copper braiding, 85 % coverage |
| Length | L | 40 m |
| Cable code | | Li 9Y V1 C V1 11Y 8 x 0,25 |
| Material | | |
| Halogen-free | | yes |
| Plug connector | | |
| Screw connection | | Zinc diecast, nickel-plated |
| Body | | TPU, black |
| Seal | | FKM |
| Contact surface | | gold plated (Au) |
| Flammability | | V-2 |
| Cable | | |
| Sheathing | | PUR based on polyether |
| Core insulation | | PP |
| Chemical resistance | | good |

Connection Assignment



Accessories

| | | |
|---|------------------------------|--|
|  | MH V1-SCREWDRIVER | Torque screwdriver (0.6 Nm) |
|  | MH V1-BIT M12 | plug-in cap M12 |
|  | V1/V3-LABELHOLDER | Label holder |
|  | V1/V3-LABEL | Label plate |
|  | MH V1-Holder | Modular universal holder for M12 connectors |
|  | V1-CLIP | Unlocking protector for M12 connector |
|  | V1-MARKING-RING-COLOR | Marking rings for M12 connectors, various colors |