

## Thru-beam sensor (pair)

### OBE500-R2F-SE2-Y253562



- Very flat design for direct mounting without mounting bracket
- TEACH-IN
- Detection of partially transparent objects by teach-in
- Very bright, highly visible light spot

Thru-beam sensor, flat design, space-saving M2 mounting, 500 mm detection range, red light, dark on, PNP output, fixed cable



## Dimensions

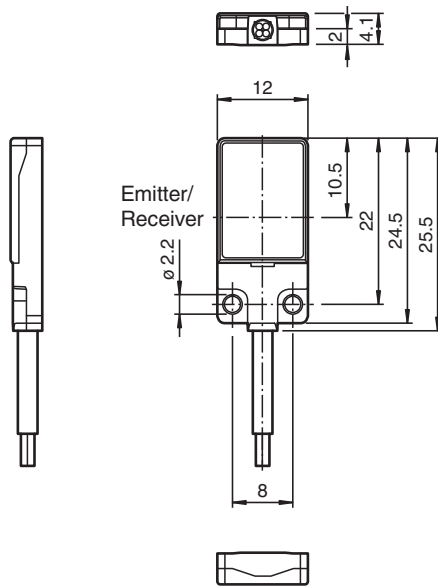

## Technical Data

### System components

Emitter	OBE500-R2F-S
Receiver	OBE500-R2F-E2-Y813035

### General specifications

Effective detection range	0 ... 500 mm
Threshold detection range	700 mm
Light source	LED
Light type	modulated visible red light , 630 nm

Release date: 2023-04-05 Date of issue: 2023-04-05 Filename: 253562\_eng.pdf

## Technical Data

LED risk group labelling		exempt group
Angle deviation		approx. 2 °
Object size		typ. starts from 1.5 mm
Diameter of the light spot		approx. 90 mm at a distance of 500 mm
Opening angle		approx. 5 °
Optical face		frontal
Ambient light limit		EN 60947-5-2 : 25000 Lux
<b>Functional safety related parameters</b>		
MTTF <sub>d</sub>		806 a
Mission Time (T <sub>M</sub> )		20 a
Diagnostic Coverage (DC)		0 %
<b>Indicators/operating means</b>		
Operation indicator		LED green, statically lit Power on , short-circuit : LED green flashing (approx. 4 Hz)
Function indicator		Receiver: LED yellow, lights up when light beam is free, flashes when falling short of the operating reserve ; OFF when light beam is interrupted
<b>Electrical specifications</b>		
Operating voltage	U <sub>B</sub>	10 ... 30 V DC
No-load supply current	I <sub>0</sub>	< 10 mA
Protection class		III
<b>Input</b>		
Test input		Test of switching function at 0 V
Switching threshold		Teach-In input
<b>Output</b>		
Switching type		NO contact / dark-on
Signal output		1 PNP output, short-circuit protected, reverse polarity protected, open collector
Switching voltage		max. 30 V DC
Switching current		max. 50 mA , resistive load
Voltage drop	U <sub>d</sub>	≤ 1.5 V DC
Switching frequency	f	approx. 1 kHz
Response time		500 μs
<b>Conformity</b>		
Product standard		EN 60947-5-2
<b>Approvals and certificates</b>		
UL approval		E87056 , cULus Recognized, Class 2 Power Source
CCC approval		CCC approval / marking not required for products rated ≤36 V
<b>Ambient conditions</b>		
Ambient temperature		-20 ... 60 °C (-4 ... 140 °F)
Storage temperature		-20 ... 70 °C (-4 ... 158 °F)
<b>Mechanical specifications</b>		
Housing width		12 mm
Housing height		25.5 mm
Housing depth		4.1 mm
Degree of protection		IP67
Connection		2 m fixed cable
<b>Material</b>		
Housing		PC (Polycarbonate) and Stainless steel
Optical face		PMMA
Cable		PUR
Mass		approx. 20 g per sensor
Tightening torque, fastening screws		0.25 Nm
Cable length		2 m

**Connection**

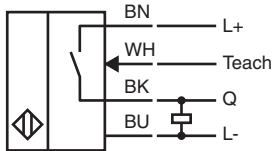
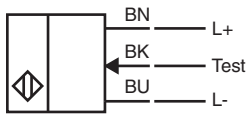

**Characteristic Curve**

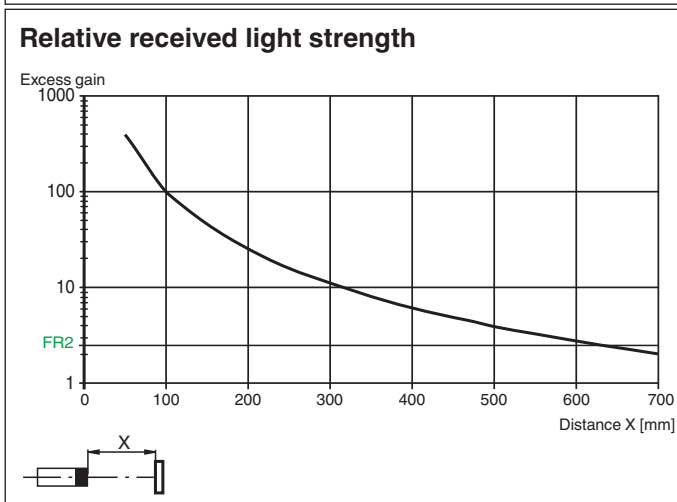
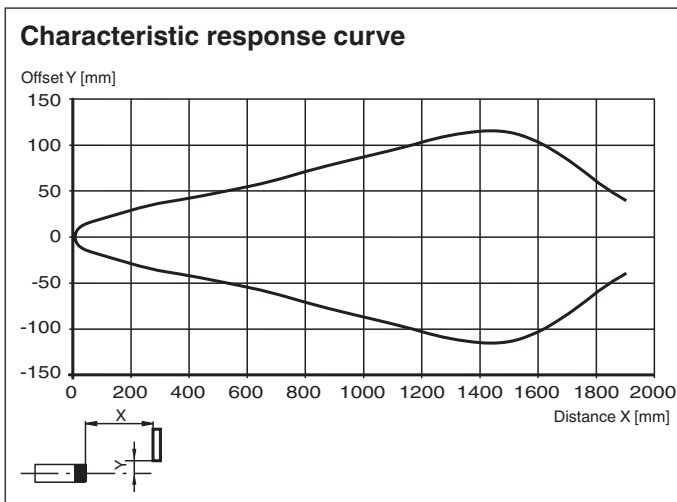

Release date: 2023-04-05 Date of issue: 2023-04-05 Filename: 253562\_eng.pdf

### Characteristic Curve

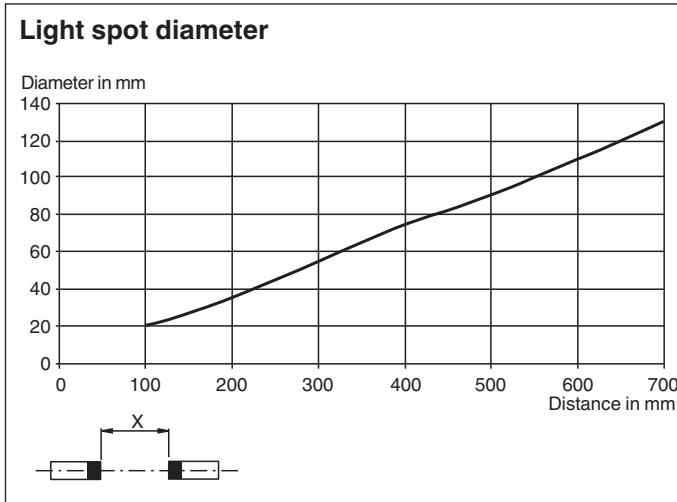

Release date: 2023-04-05 Date of issue: 2023-04-05 Filename: 253562\_eng.pdf

**Teach-In**

The thru-beam sensor enables the switching points to be taught in for optimum adaptation to specific applications. This eliminates the need for additional components such as apertures.

The sensitivity of the thru-beam sensor can be adjusted using three Teach-in methods:

**Position Teach**

When using this Teach-in method, the following settings are made on the thru-beam sensor:

- The gain is set to an optimum value
- The signal threshold is set to a minimum

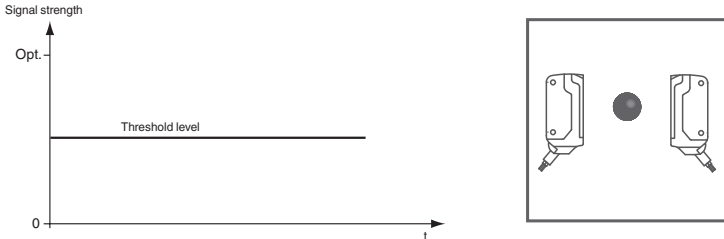

Recommended application:

This method enables minuscule particles in the beam path to be detected, and provides exceptional positioning accuracy. Make sure that there are no objects in the beam path and that the sensor is connected to the power supply.

1. Connect the white cable on the receiver (WH/IN) to the blue cable (BU/0 V) on the receiver.  
The green and yellow LED indicators flash simultaneously at 2.5 Hz
2. Disconnect the white cable on the receiver (WH/IN) from the blue cable (BU/0 V) on the receiver.  
The green and yellow LED indicators flash alternately at 2.5 Hz
3. The end of the Teach-in process is indicated when the green LED indicator lights up static and yellow LED blinks.

**Two-Point Teach-In**

When using this Teach-in method, the following settings are made on the thru-beam sensor:

- The gain is set to an optimum value
- The signal threshold is set in the center between the two taught signal values

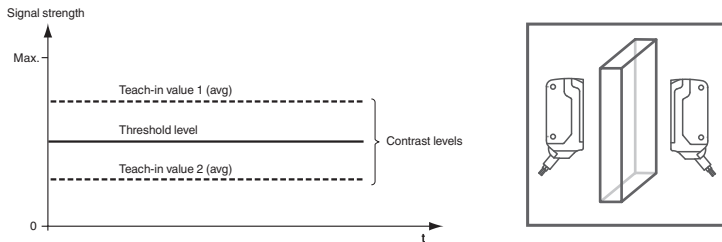

1. Make sure that there are no objects in the beam path and that the sensor is connected to the power supply.
2. Connect the white cable on the receiver (WH/IN) to the blue cable (BU/0 V) on the receiver.  
The green and yellow LED indicators flash simultaneously at 2.5 Hz
3. Position the object in the beam path.
4. Disconnect the white cable on the receiver (WH/IN) from the blue cable (BU/0 V) on the receiver.  
The green and yellow LED indicators flash alternately at 2.5 Hz
5. The end of the Teach-in process is indicated when the green LED indicator lights up static.

**Maximum Teach-In**

When using this Teach-in method, the following settings are made on the thru-beam sensor:

- The gain is set to a maximum
- The signal threshold is set to a minimum

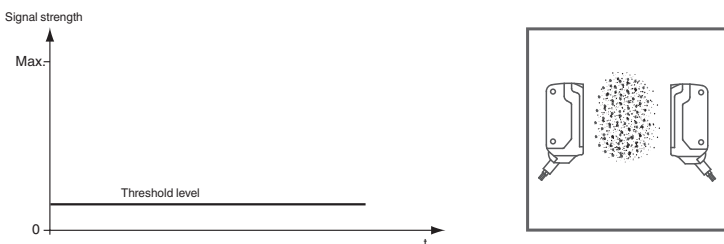

Recommended application:

Enables an object to be detected with a high excess gain. This can be useful if there is severe environmental contamination or to achieve long operating times.

Make sure that there are no objects in the beam path and that the sensor is connected to the power supply.

6. Cover the receiver or transmitter.
7. Connect the white cable on the receiver (WH/IN) to the blue cable (BU/0 V) on the receiver.

Release date: 2023-04-05 Date of issue: 2023-04-05 Filename: 253562\_eng.pdf

The green and yellow LED indicators flash simultaneously at 2.5 Hz

8. Disconnect the white cable on the receiver (WH/IN) from the blue cable (BU/0 V) on the receiver.  
The green and yellow LED indicators flash alternately at 2.5 Hz
9. The end of the Teach-in process is indicated when the green LED indicator lights up static.