

Triangulation sensor (BGS)

OBT30-R2F-E2



- Very flat design for direct mounting without mounting bracket
- Precision object detection, almost irrespective of the color
- Small parts detection from 0.1 mm
- Highly visible light spot, even on dark materials
- High degree of immunity to extraneous light

Triangulation sensor with background suppression for standard applications, flat design, space-saving M2 mounting, 30 mm sensing range, red light, light on, PNP output, fixed cable



Dimensions

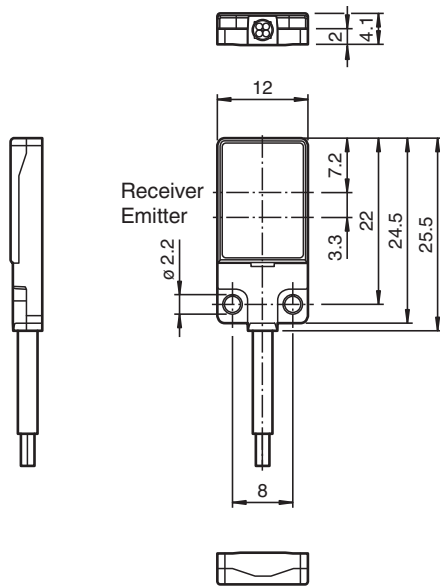

Technical Data

General specifications	
Detection range	1 ... 30 mm
Reference target	standard white, 100 mm x 100 mm
Light source	LED
Light type	modulated visible red light , 630 nm
LED risk group labelling	exempt group
Black-white difference (6 %/90 %)	< 20 % at 30 mm
Angle deviation	approx. 2 °
Object size	typ. starts from 0.1 mm @ 16 mm

Release date: 2023-04-05 Date of issue: 2023-04-05 Filename: 253570_eng.pdf

Technical Data

Diameter of the light spot	approx. 5.5 mm at a distance of 30 mm	
Opening angle	approx. 5 °	
Optical face	frontal	
Ambient light limit	EN 60947-5-2 : 25000 Lux	
Functional safety related parameters		
MTTF _d	800 a	
Mission Time (T _M)	20 a	
Diagnostic Coverage (DC)	0 %	
Indicators/operating means		
Operation indicator	LED green, statically lit Power on , short-circuit : LED green flashing (approx. 4 Hz)	
Function indicator	LED yellow ON: lights when object is detected	
Electrical specifications		
Operating voltage	U _B	10 ... 30 V DC
No-load supply current	I ₀	< 15 mA
Protection class	III	
Output		
Switching type	NO contact / light-on	
Signal output	1 PNP output, short-circuit protected, reverse polarity protected, open collector	
Switching voltage	max. 30 V DC	
Switching current	max. 50 mA , resistive load	
Voltage drop	U _d	≤ 1.5 V DC
Switching frequency	f	approx. 1 kHz
Response time	500 μs	
Conformity		
Product standard	EN 60947-5-2	
Approvals and certificates		
UL approval	E87056 , cULus Recognized, Class 2 Power Source	
CCC approval	CCC approval / marking not required for products rated ≤36 V	
Ambient conditions		
Ambient temperature	-20 ... 60 °C (-4 ... 140 °F)	
Storage temperature	-20 ... 70 °C (-4 ... 158 °F)	
Mechanical specifications		
Housing width	12 mm	
Housing height	25.5 mm	
Housing depth	4.1 mm	
Degree of protection	IP67	
Connection	2 m fixed cable	
Material		
Housing	PC (Polycarbonate) and Stainless steel	
Optical face	PMMA	
Cable	PUR	
Mass	approx. 20 g	
Tightening torque, fastening screws	0.25 Nm	
Cable length	2 m	

Connection

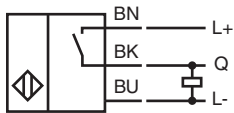

Characteristic Curve

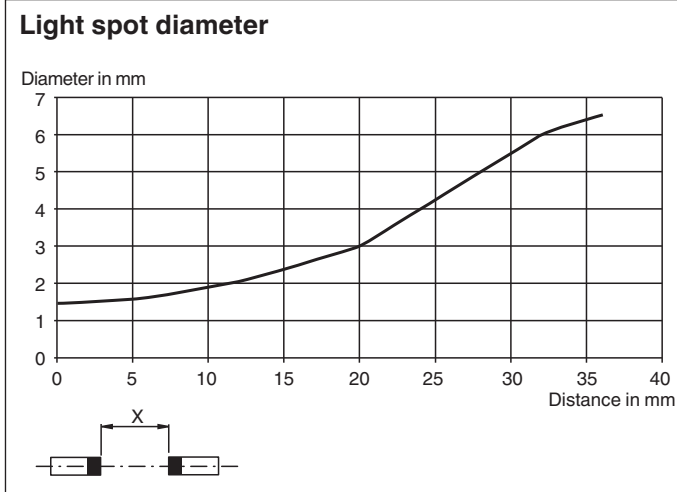
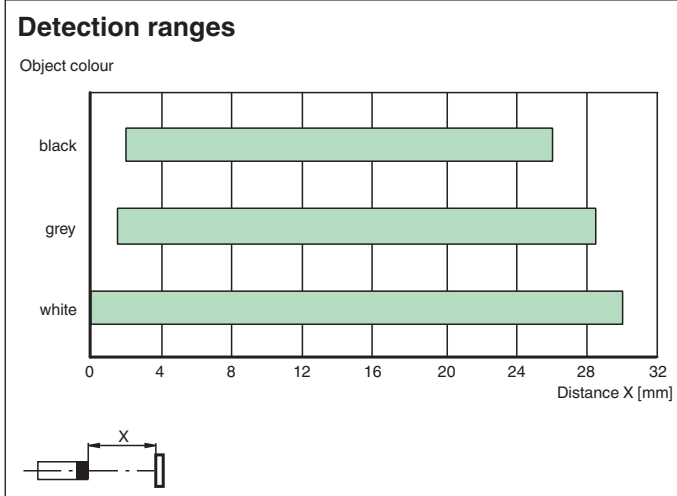
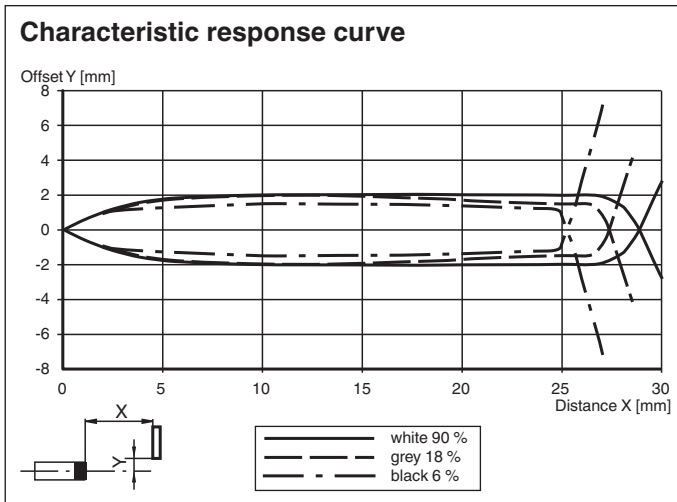

Release date: 2023-04-05 Date of issue: 2023-04-05 Filename: 253570_eng.pdf