

# Female cordset

## V1-W-S-BK10M-PUR-A



- Improved resistance to weld spatter
- Suitable for drag chains and abrasion resistant
- Suitable for robotic applications / torsion resistant
- Degree of protection IP68 / IP69
- Free of paint wetting interfering substances
- Resistant to microbes and hydrolysis
- UL listed for USA and Canada
- Halogen-free
- Specific design protects against loosening and inaccurate installation

Female cordset single-ended M12 yellow angled A-coded, 4-pin, PUR cable weld spatter resistant black, UL approved, drag chain suitable, torsion resistant



### Dimensions

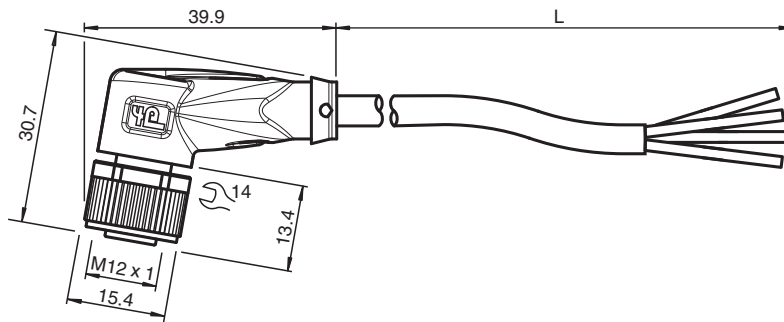

### Technical Data

General specifications		
Connector 1		
Connection		socket
Construction type		M12
Style		angled
Locking		screw connection
Number of pins		4
Coding		A-coded
Connector 2		
Connection		cable end
Electrical specifications		
Operating voltage	$U_B$	max. 250 V AC/DC
Operating current	$I_B$	max. 4 A
Conformity		
Degree of protection		EN 60529
Plug connection		connector M12 x 1 : IEC 61076-2-101
Flammability		UL 1581; DIN EN 60332-2-2
Halogen-free		DIN VDE 0472-815 IEC 60754-1
Microbial resistance		DIN EN 50525-2-21 / DIN VDE 0282-10
Hydrolysis resistance		DIN EN 50525-2-21

Release date: 2023-09-04 Date of issue: 2023-09-05 Filename: 254644\_eng.pdf

## Technical Data

### Approvals and certificates

UL approval	AWM STYLE 20549 AWM I/II A/B 80°C 300V FT2 (cable)
UL File Number	E231213

### Ambient conditions

Ambient temperature	
Plug connector	-40 ... 90 °C (-40 ... 194 °F)
Cable, fixed	-40 ... 80 °C (-40 ... 176 °F)
Cable, flexing	-25 ... 80 °C (-13 ... 176 °F)
Pollution degree	3

### Mechanical specifications

Plug connector	
Tightening torque	0.6 Nm
Loosening protection	available
Tool installation	straight knurling and hexagon nut SW = 14 mm
Mating cycles	min. 100
Degree of protection	IP68 / IP69
Cable	according to IEC/EN 60228 (DIN VDE 0295) class 6
Sheath diameter	4.3 mm
Bending radius	> 10 x cable diameter, moving > 5 x cable diameter, fixed
Sheath stripping force	max. 80 N / 300 mm
Sheath color	black (similar to RAL 9005)
Number of cores	4
Core cross section	0.34 mm <sup>2</sup>
Cores color	Core 1: brown Core 2: white Core 3: blue Core 4: black
Core construction	42 x 0.1 mm Ø
Length	L 10 m
Cable code	Li F 9Y 11Y 4 x 0,34
Drag chain suitability	
Drag chain cycles	min. 5000000
Motion velocity	max. 3.3 m/s
Traverse distance	max. 5 m
Acceleration	max. 5 m/s <sup>2</sup>
Torsion cycles	min. 1000000
Torsional stress	± 180 °/m

### Material

PWIS free	yes
Halogen-free	yes
Plug connector	
Screw connection	Zinc diecast, nickel-plated
Body	TPU, yellow
Seal	FKM
Contact surface	gold plated (Au)
Flammability	V-2
Cable	
Sheathing	PUR based on polyether
Core insulation	PP
Weld spatter resistance	yes
Chemical resistance	good
Oil resistance	yes
Cooling lubricant resistance	yes

### Technical Data





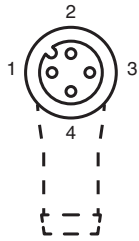

Microbial resistance	yes
Hydrolysis resistance	yes
Flammability	FT2

### Connection



1	BN
2	WH
3	BU
4	BK

### Accessories

	<b>MH V1-SCREWDRIVER</b>	Torque screwdriver (0.6 Nm)
	<b>MH V1-BIT M12</b>	plug-in cap M12
	<b>V1/V3-LABELHOLDER</b>	Label holder
	<b>V1/V3-LABEL</b>	Label plate
	<b>MH V1-Holder</b>	Modular universal holder for M12 connectors
	<b>V1-CLIP</b>	Unlocking protector for M12 connector
	<b>V1-MARKING-RING-COLOR</b>	Marking rings for M12 connectors, various colors