



# Transmitter Power Supply KFD2-CRG2-Ex1.D

- 1-channel isolated barrier
- 24 V DC supply (Power Rail)
- Input 2-wire and 3-wire transmitters and 2-wire current sources
- Output 0/4 mA ... 20 mA
- 2 relay contact outputs
- Adjustable energized/de-energized delay
- Programmable high/low alarm
- Linearization function (max 20 points)
- Line fault detection (LFD)
- Up to SIL 2 acc. to IEC/EN 61508 / IEC/EN 61511



## Function

This isolated barrier is used for intrinsic safety applications. The device supplies 2-wire and 3-wire transmitters, and can also be used with current sources. Two relays and an active 0/4 mA to 20 mA current source are available as outputs. The relay contacts and the current output can be integrated in safety-relevant circuits. The current output is easily scaled. On the display the measured value can be indicated in various physical units. The device is easily configured by the use of keypad or with the PACTware configuration software. The input has a line fault detection. A fault is signaled by LEDs and a separate collective error message output. For additional information, refer to the manual and [www.pepperl-fuchs.com](http://www.pepperl-fuchs.com).

## Connection

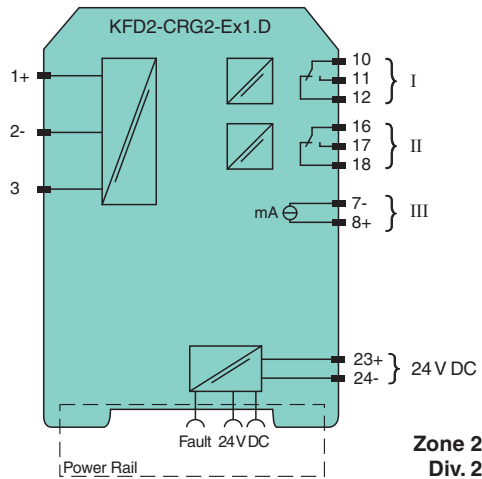
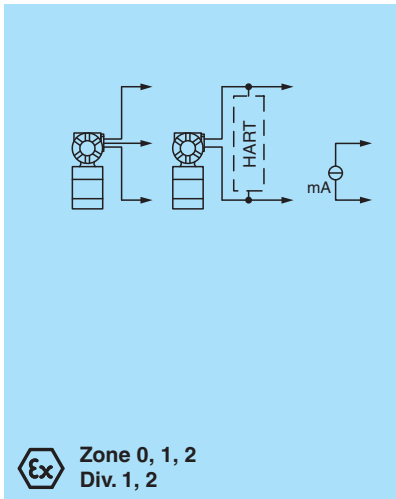

## Technical Data

General specifications	
Signal type	Analog input
Functional safety related parameters	
Safety Integrity Level (SIL)	SIL 2
Supply	
Connection	Power Rail or terminals 23+, 24-
Rated voltage	$U_r$ 20 ... 30 V DC
Rated current	$I_r$ approx. 130 mA
Power dissipation	2 W

Release date: 2023-05-31 Date of issue: 2023-05-31 Filename: 255620\_eng.pdf

## Technical Data

Power consumption	2.5 W
<b>Interface</b>	
Programming interface	programming socket
<b>Input</b>	
Connection side	field side
Connection	terminals 1, 2, 3
Input I	
Input signal	0/4 ... 20 mA
Available voltage	≥ 15 V at 20 mA
Open circuit voltage/short-circuit current	24 V / 33 mA
Input resistance	45 Ω (terminals 2, 3)
Line fault detection	breakage I < 0.2 mA; short-circuit I > 22 mA
<b>Output</b>	
Connection side	control side
Connection	output I: terminals 10, 11, 12 output II: terminals 16, 17, 18 output III: terminals 8+, 7-
Output signal	0 ... 20 mA or 4 ... 20 mA
Output I, II	signal, relay
Contact loading	253 V AC / 2 A / cos φ ≥ 0.7 ; 40 V DC / 2 A
Mechanical life	5 x 10 <sup>7</sup> switching cycles
Output III	Signal, analog
Current range	0 ... 20 mA or 4 ... 20 mA
Open loop voltage	max. 24 V DC
Load	max. 650 Ω
Fault signal	downscale I ≤ 3.6 mA, upscale I ≥ 21 mA (acc. NAMUR NE43)
Energized/De-energized delay	0 ... 250 s , adjustable
<b>Transfer characteristics</b>	
Input I	
Accuracy	< 30 μA
Influence of ambient temperature	0.003 %/K (30 ppm)
Output I, II	
Response delay	≤ 200 ms at bounce from 0 ... 20 mA
Output III	
Resolution	≤ 10 μA
Accuracy	< 20 μA
Influence of ambient temperature	0.005 %/K (50 ppm)
Reaction time	< 650 ms at bounce from 0 ... 20 mA at the input, 90 % of output full-scale value
<b>Galvanic isolation</b>	
Input/Other circuits	reinforced insulation according to IEC/EN 61010-1, rated insulation voltage 300 V <sub>eff</sub>
Output I, II/other circuits	reinforced insulation according to IEC/EN 61010-1, rated insulation voltage 300 V <sub>eff</sub>
Mutual output I, II, III	reinforced insulation according to IEC/EN 61010-1, rated insulation voltage 300 V <sub>eff</sub>
Output III/power supply and collective error	functional insulation acc. to IEC 62103, rated insulation voltage 50 V <sub>eff</sub>
Interface/power supply and collective error	functional insulation acc. to IEC 62103, rated insulation voltage 50 V <sub>eff</sub>
<b>Indicators/settings</b>	
Display elements	LEDs , display
Control elements	Control panel
Configuration	via operating buttons via PACTware
Labeling	space for labeling at the front
<b>Directive conformity</b>	
Electromagnetic compatibility	
Directive 2014/30/EU	EN 61326-1:2013 (industrial locations)
Low voltage	

## Technical Data

Directive 2014/35/EU		EN 61010-1:2010
<b>Conformity</b>		
Electromagnetic compatibility		NE 21:2006
Degree of protection		IEC 60529:2001
<b>Ambient conditions</b>		
Ambient temperature		-20 ... 60 °C (-4 ... 140 °F)
<b>Mechanical specifications</b>		
Degree of protection		IP20
Connection		screw terminals
Mass		300 g
Dimensions		40 x 119 x 115 mm (1.6 x 4.7 x 4.5 inch) (W x H x D) , housing type C2
Mounting		on 35 mm DIN mounting rail acc. to EN 60715:2001
<b>Data for application in connection with hazardous areas</b>		
EU-type examination certificate		TÜV 01 ATEX 1701
Marking		Ⓢ II (1)G [Ex ia Ga] IIC Ⓢ II (1)D [Ex ia Da] IIIC Ⓢ I (M1) [Ex ia Ma] I
Input		Ex ia
Supply		
Maximum safe voltage	U <sub>m</sub>	40 V DC (Attention! The rated voltage can be lower.)
Equipment		terminals 1+, 3-
Voltage	U <sub>o</sub>	25.8 V
Current	I <sub>o</sub>	93 mA
Power	P <sub>o</sub>	0.603 W
Equipment		terminals 2-, 3
Voltage	U <sub>i</sub>	< 30 V
Current	I <sub>i</sub>	115 mA
Voltage	U <sub>o</sub>	5 V
Current	I <sub>o</sub>	0.3 mA
Power	P <sub>o</sub>	0.3 mW
Equipment		terminals 1+, 2 / 3-
Voltage	U <sub>o</sub>	25.8 V
Current	I <sub>o</sub>	112 mA
Power	P <sub>o</sub>	720 mW
Output I, II		terminals 10, 11, 12; 16, 17, 18 non-intrinsically safe
Maximum safe voltage	U <sub>m</sub>	253 V AC / 40 V DC (Attention! U <sub>m</sub> is no rated voltage.)
Contact loading		253 V AC/2 A/cos φ > 0.7; 40 V DC/2 A resistive load
Output III		terminals 8+, 7- non-intrinsically safe
Maximum safe voltage U <sub>m</sub>	U <sub>m</sub>	40 V (Attention! The rated voltage can be lower.)
Interface		RS 232
Maximum safe voltage	U <sub>m</sub>	40 V (Attention! The rated voltage can be lower.) , RS 232
Certificate		TÜV 02 ATEX 1885 X
Marking		Ⓢ II 3G Ex nA nC IIC T4
Output I, II		
Contact loading		50 V AC/2 A/cos φ > 0.7; 40 V DC/2 A resistive load
Galvanic isolation		
Input/Other circuits		safe electrical isolation acc. to IEC/EN 60079-11, voltage peak value 375 V
Directive conformity		
Directive 2014/34/EU		EN 60079-0:2012+A11:2013 , EN 60079-11:2012 , EN 60079-15:2010
<b>International approvals</b>		
FM approval		
Control drawing		16-554FM-12 (cFMus)
UL approval		E223772

## Technical Data

IECEX approval	
IECEX certificate	IECEX TUN 09.0007 IECEX TSA 18.0007X
IECEX marking	[Ex ia Ga] IIC, [Ex ia Da] IIIC, [Ex ia Ma] I Ex ec nC IIC T4 Gc
<b>General information</b>	
Supplementary information	Observe the certificates, declarations of conformity, instruction manuals, and manuals where applicable. For information see <a href="http://www.pepperl-fuchs.com">www.pepperl-fuchs.com</a> .

## Assembly

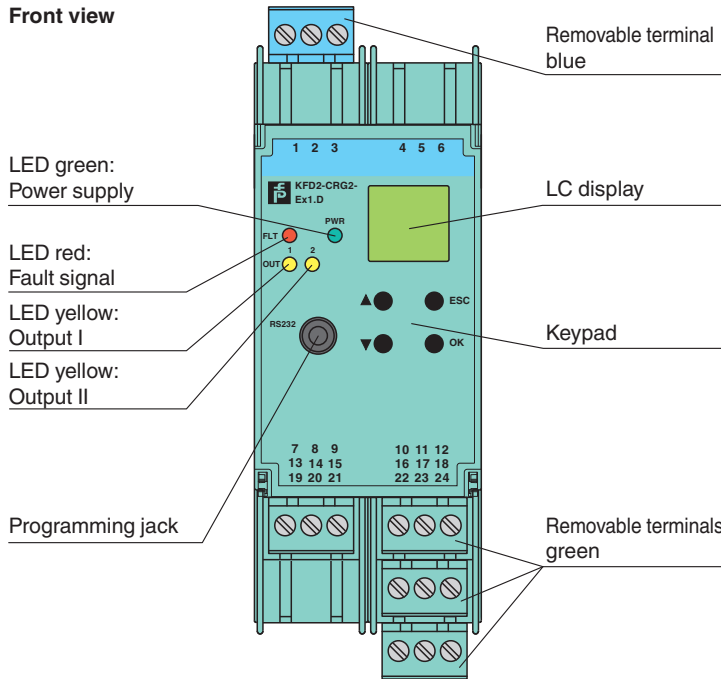



## Matching System Components





	<b>DTM Interface Technology</b>	Device type manager (DTM) for interface technology
	<b>PACTware 5.0</b>	FDT Framework
	<b>K-ADP-USB</b>	Programming adapter with USB interface
	<b>KFD2-EB2</b>	Power Feed Module
	<b>UPR-03</b>	Universal Power Rail with end caps and cover, 3 conductors, length: 2 m
	<b>UPR-03-M</b>	Universal Power Rail with end caps and cover, 3 conductors, length: 1,6 m
	<b>UPR-03-S</b>	Universal Power Rail with end caps and cover, 3 conductors, length: 0.8 m

Release date: 2023-05-31 Date of issue: 2023-05-31 Filename: 255620\_eng.pdf

## Matching System Components

	<b>K-DUCT-BU</b>	Profile rail, wiring comb field side, blue
	<b>K-DUCT-BU-UPR-03</b>	Profile rail with UPR-03- * insert, 3 conductors, wiring comb field side, blue

## Accessories

	<b>K-250R</b>	Measuring resistor
	<b>K-500R0%1</b>	Measuring resistor
	<b>KF-ST-5GN</b>	Terminal block for KF modules, 3-pin screw terminal, green
	<b>KF-ST-5BU</b>	Terminal block for KF modules, 3-pin screw terminal, blue
	<b>KF-CP</b>	Red coding pins, packaging unit: 20 x 6

**Characteristic Curve**

**Maximum Switching Power of Output Contacts**

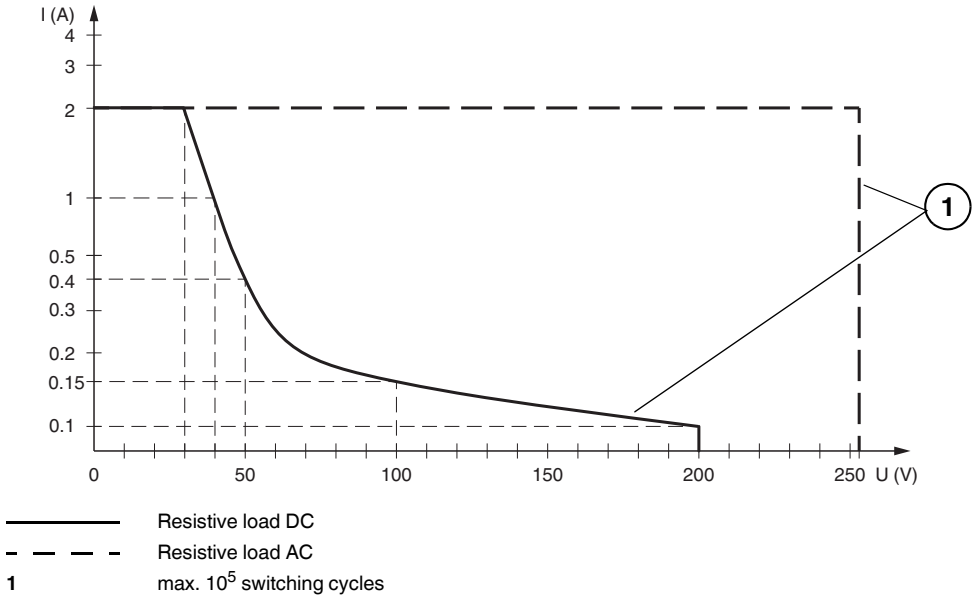

Release date: 2023-05-31 Date of issue: 2023-05-31 Filename: 255620\_eng.pdf