

RFID read/write device

IUH-F192-V1-FR1



- Flexible UHF read/write head with long range for use worldwide
- Ready-made PLC function blocks designed for quick and easy system integration
- Compact and robust housing for harsh industrial environments
- Switchable antenna polarization guarantees reliable tag detection and enhances process flow
- For connection to IDENTControl control interface
- Multi-tag reading increases productivity

UHF RFID read/write device for IDENTControl, Europe, Middle East and Africa



Function

The IUH-F192-V1-FR1 read/write head operates in the UHF frequency range and is optimized for use in industrial applications involving greater distances. The device reads and writes passive tags in line with EPC Generation 2 (ISO/IEC 18000-63). The dense reader mode that has been implemented, which operates in accordance with ETSI EN 302208-1, prevents read/write heads installed in close proximity from interfering with one another.

Wide range of options supported for filtering data. The read/write head is connected to the IDENTControl interface using an M12 connector. The user can monitor the status of the read/write head using the integrated LEDs.

The read/write head has a typical detection range of around 4 meter; this range is determined by the tag used and can be adjusted by selecting the transmission power. Other influencing factors include the setup and installation for the specific application in question, interference from materials present in the area (in particular metal), and the ambient conditions. The read and write distances for the relevant tag, which are detailed separately, have been established in a test laboratory under ideal conditions. For this reason, the combination of read/write head and tag must be tested for the intended application under real conditions.

This product is a wireless device and may be operated only in the country for which a transmission license exists. Information regarding transmission licenses can be found on the datasheet for the product. If a product is released to a customer in a country for which there is no transmission license, the product may be operated only in the country for which a transmission license exists.

If a product does not correspond to the legal requirements in force in the EU but is released to a purchaser within the EU, the product is intended for use solely in the destination country of the end customer outside of the EU for which a transmission license exists. The product may therefore under no circumstances be used directly by the purchaser or released to third parties for the purpose of distribution, application or use on the market within the EU as part of a commercial activity.

In the event of an infringement, the purchaser is obliged to indemnify the supplier against any resulting damages, costs, penalty payments and other expenses.

Dimensions

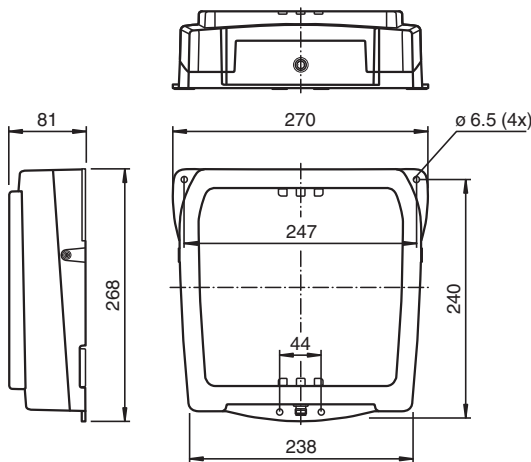

Technical Data

General specifications

Operating frequency

865 ... 868 MHz: EU, Turkey
Transmission licenses for other countries on request



Technical Data

Emitted power		10 ... 2000 mW ERP (ETSI 302208) adjustable
Operating distance		typ. 4 m
MTBF		64 a (Operation at +40 °C)
Indicators/operating means		
LED green		Power on
LED yellow		Read/write operation successful
LED blue		Transmission mode
Electrical specifications		
Power consumption	P_0	≤ 10 W
Supply		from the IDENTControl
Directive conformity		
Radio equipment		
Directive 2014/53/EU		EN 301489-1 EN 301489-3 EN 302208 EN 62368-1 EN 62311 EN 50364
RoHS		
Directive 2011/65/EU (RoHS)		IEC/EN 63000
Standard conformity		
Degree of protection		EN 60529
RFID		ISO/IEC 18000-63
Ambient conditions		
Ambient temperature		-25 ... 70 °C (-13 ... 158 °F)
Storage temperature		-40 ... 85 °C (-40 ... 185 °F)
Mechanical specifications		
Housing length		268 mm
Housing width		270 mm
Housing height		81 mm
Degree of protection		IP67
Connection		connector M12 x 1
Material		
Housing		PA 6
Base		diecast aluminum
Mass		approx. 3000 g

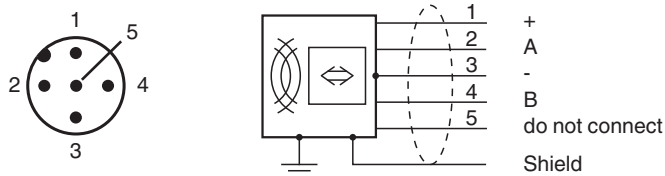













Connection



Accessories

	IC-KP-B17-AIDA1	IDENTControl control interface with Ethernet interface for TCP/IP, PROFINET, EtherNet/IP, and MODBUS TCP protocols
	IC-KP2-2HRX-2V1	Control interface unit IDENTControl Compact with serial interface RS-232 and RS-485

Accessories

	IC-KP2-2HB6-V15B	Control interface unit IDENTControl Compact with interface for PROFIBUS DP
	IC-KP2-2HB17-2V1D	IDENTControl Compact control interface with Ethernet interface for TCP/IP, PROFINET, EtherNet/IP, and MODBUS TCP protocols
	IC-KP2-2HB21-2V1D	Control interface unit IDENTControl Compact with EtherCAT interface
	IUC76-F157-T17-M-FR1	Data carrier for standard applications
	IUC76-F157-T18-M-FR1	Data carrier for paint shop applications
	IUC77-25L100-GBL 1000pcs	Data carrier
	IUC77-28L90-M-FR1 25pcs	Data carrier
	IUC77-34-M-FR1 10pcs	Data carrier
	IUC77-50-FR1 10pcs	Data carrier
	IUZ-MH13	Mounting bracket for wall mounting
	IUZ-MH15	Mounting aid for round steel ø 12 mm or sheet 1.5 mm ... 3 mm
	V1-G-2M-PUR-ABG-V1-W	Cordset M12 socket straight to M12 plug angled A-coded, 4-pin, PUR cable grey, shielded
	V1-G-5M-PUR-ABG-V1-W	Cordset M12 socket straight to M12 plug angled A-coded, 4-pin, PUR cable grey, shielded
	V1-G-10M-PUR-ABG-V1-W	Cordset M12 socket straight to M12 plug angled A-coded, 4-pin, PUR cable grey, shielded