

Diffuse mode sensor OBD300-12GM40-E5



- Robust M12 threaded housing
- Less space required
- Light-on/dark-on, programmable
- Degree of protection IP67

Diffuse mode sensor, M12 threaded housing design, metal housing, front optical face, 300 mm detection range, red light, light/dark on, 1 PNP output, fixed cable



Dimensions

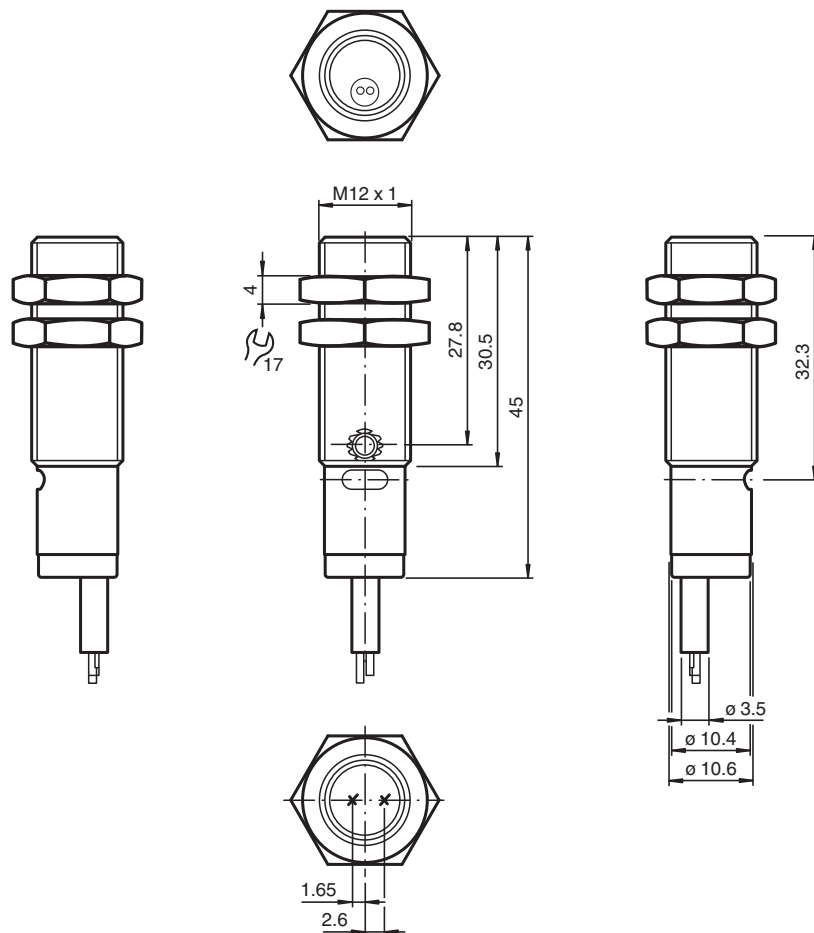

Technical Data

General specifications

Detection range 0 ... 300 mm

Technical Data

Adjustment range		20 ... 300 mm
Reference target		standard white 100 mm x 100 mm
Light source		LED
Light type		red , 640 nm
Angle deviation		+/- 2 °
Diameter of the light spot		approx. 20 mm at a distance of 300 mm
Opening angle		approx. 4 °
Optical face		frontal
Ambient light limit		EN 60947-5-2 10000 Lux
Functional safety related parameters		
MTTF _d		800 a
Mission Time (T _M)		20 a
Diagnostic Coverage (DC)		0 %
Indicators/operating means		
Operation indicator		LED green: Power on
Function indicator		LED yellow ON: lights when object is detected
Control elements		Sensing range adjuster
Electrical specifications		
Operating voltage	U _B	10 ... 30 V DC , class 2
Ripple		10 %
No-load supply current	I ₀	≤ 15 mA
Input		
Control input		light on +UB dark on: 0 V
Output		
Switching type		light/dark on electrically switchable
Signal output		1 PNP output, short-circuit protected, reverse polarity protected, open collector
Switching voltage		max. 30 V DC
Switching current		max. 100 mA , resistive load
Voltage drop	U _d	≤ 2 V
Switching frequency	f	≤ 1000 Hz
Response time		0.5 ms
Conformity		
Product standard		EN 60947-5-2
Compliance with standards and directives		
Standard conformity		
Standards		UL 508
Approvals and certificates		
UL approval		cULus Listed, Class 2 Power Source, Type 1 enclosure
CCC approval		CCC approval / marking not required for products rated ≤36 V
Approvals		CE, cULus Listed 57M3 (Only in association with UL Class 2 power supply; Type 1 enclosure)
Ambient conditions		
Ambient temperature		-30 ... 60 °C (-22 ... 140 °F)
Storage temperature		-40 ... 70 °C (-40 ... 158 °F)
Mechanical specifications		
Degree of protection		IP67
Connection		2 m fixed cable
Material		
Housing		brass, nickel-plated
Optical face		PMMA
Mass		approx. 45 g
Cable length		2 m

Connection

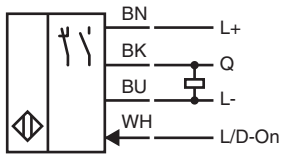

Assembly

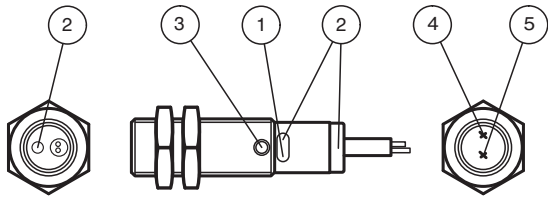

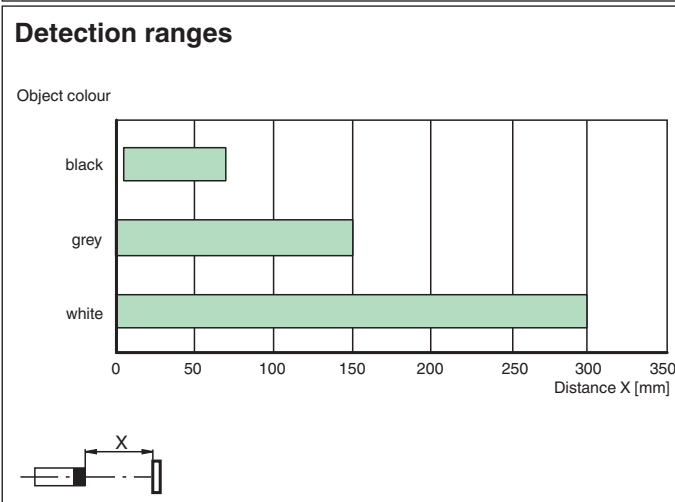
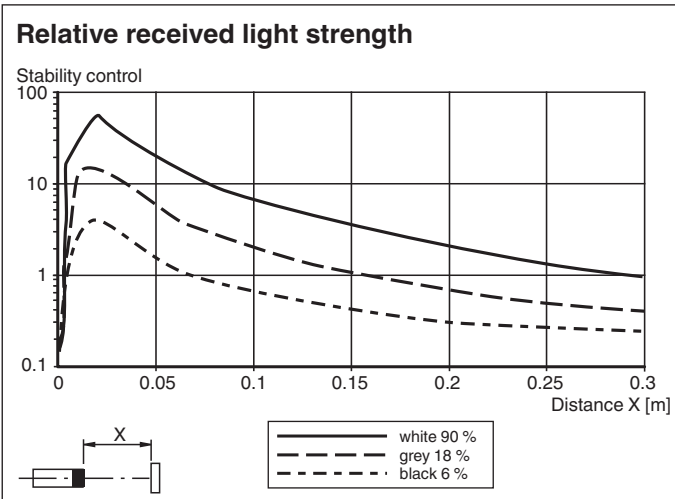

1	Operating display	green
2	Signal display	yellow
3	Potentiometer	
4	Emitter	
5	Receiver	

Characteristic Curve



Release date: 2023-03-28 Date of issue: 2023-03-28 Filename: 257829_eng.pdf

Accessories

	BF 12	Mounting flange, 12 mm
	BF 12-F	Plastic mounting adapter, 12 mm
	BF 5-30	Universal mounting bracket for cylindrical sensors with a diameter of 5 ... 30 mm