

Y connection cable

V1-G-S-2M-T-0,6M-PUR-A-V1-G

- Easy merging of two signals at a single M12 slot
- Improved resistance to weld spatter
- Suitable for drag chains and abrasion resistant
- Suitable for robotic applications / torsion resistant
- Free of paint wetting interfering substances
- Resistant to microbes and hydrolysis
- cURus approval
- Halogen-free
- Knurled nut suitable for tool assembly
- Immunity to vibration, with mechanical latching
- Suitable for use with the deTec4 Core light curtain

Y connection cable M12 plug yellow straight A-coded 4-pin to 2x M12 socket yellow straight A-coded 4-pin, 3x PUR cable weld spatter resistant black, UL approved, drag chain suitable, torsion resistant



Dimensions

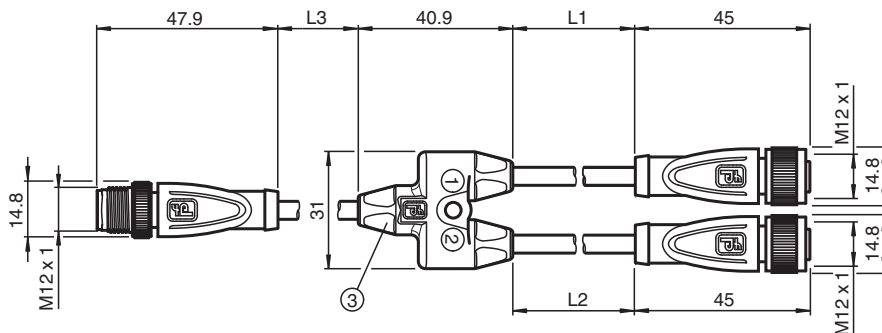

Technical Data

General specifications

| | |
|--------------------|------------------|
| Connector 1 | |
| Connection | socket |
| Construction type | M12 |
| Style | straight |
| Locking | screw connection |
| Number of pins | 4 |
| Coding | A-coded |
| Connector 2 | |
| Connection | socket |
| Construction type | M12 |
| Style | straight |
| Locking | screw connection |
| Number of pins | 4 |
| Coding | A-coded |
| Connector 3 | |
| Connection | plug |
| Construction type | M12 |
| Style | straight |

Release date: 2023-07-12 Date of issue: 2023-07-13 Filename: 259124_eng.pdf

Technical Data

| | | |
|-----------------------------------|----------------|---|
| Locking | | screw connection |
| Number of pins | | 4 |
| Coding | | A-coded |
| UL File Number | | E231213 |
| Electrical specifications | | |
| Operating voltage | U _B | max. 30 V AC/DC |
| Operating current | I _B | max. 4 A |
| Conformity | | |
| Degree of protection | | EN 60529 |
| Plug connection | | connector M12 x 1 : IEC 61076-2-101 |
| Flammability | | UL 1581; DIN EN 60332-2-2 |
| Halogen-free | | DIN VDE 0472-815 IEC 60754-1 |
| Microbial resistance | | DIN EN 50525-2-21 / DIN VDE 0282-10 |
| Hydrolysis resistance | | DIN EN 50525-2-21 |
| Approvals and certificates | | |
| UL approval | | AWM STYLE 20549 AWM I/II A/B 80°C 300V FT2 (cable) |
| Ambient conditions | | |
| Ambient temperature | | |
| Plug connector | | -40 ... 90 °C (-40 ... 194 °F) |
| Cable, fixed | | -40 ... 80 °C (-40 ... 176 °F) |
| Cable, flexing | | -25 ... 80 °C (-13 ... 176 °F) |
| Pollution degree | | 3 |
| Mechanical specifications | | |
| Plug connector | | |
| Tightening torque | | 0.6 Nm |
| Loosening protection | | available |
| Tool installation | | straight knurling |
| Mating cycles | | min. 100 |
| Degree of protection | | IP67 / IP68 / IP69 |
| Cable | | according to IEC/EN 60228 (DIN VDE 0295) class 6 |
| Sheath diameter | | 4.3 mm |
| Bending radius | | > 10 x cable diameter, moving > 5 x cable diameter, fixed |
| Sheath stripping force | | max. 80 N / 300 mm |
| Sheath color | | black (similar to RAL 9005) |
| Number of cores | | 4 |
| Core cross section | | 0.34 mm ² |
| Cores color | | Core 1: brown Core 2: white Core 3: blue Core 4: black |
| Core construction | | 42 x 0.1 mm Ø |
| Length | L | L1 = 2 m L2 = 2 m L3 = 0.6 m |
| Cable code | | Li F 9Y 11Y 4 x 0,34 |
| Drag chain suitability | | |
| Drag chain cycles | | min. 5000000 |
| Motion velocity | | max. 3.3 m/s |
| Traverse distance | | max. 5 m |
| Acceleration | | max. 5 m/s ² |
| Torsion cycles | | min. 1000000 |
| Torsional stress | | ± 180 °/m |
| Material | | |
| PWIS free | | yes |

Release date: 2023-07-12 Date of issue: 2023-07-13 Filename: 259124_eng.pdf







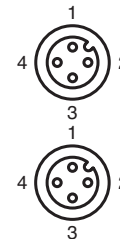
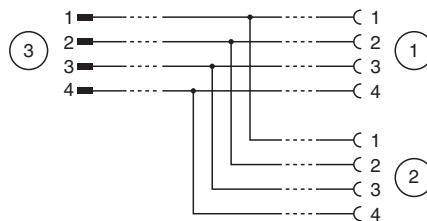
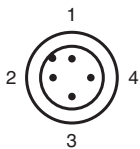

Technical Data

| | |
|------------------------------|-----------------------------|
| Halogen-free | yes |
| Plug connector | |
| Screw connection | Zinc diecast, nickel-plated |
| Body | TPU, yellow |
| Contact surface | Au |
| Flammability | V-2 |
| Cable | |
| Sheathing | PUR based on polyether |
| Core insulation | PP |
| Weld spatter resistance | yes |
| Chemical resistance | good |
| Oil resistance | yes |
| Cooling lubricant resistance | yes |
| Microbial resistance | yes |
| Hydrolysis resistance | yes |
| Flammability | FT2 |

Connection



Accessories

| | | |
|---|-------------------------------|--|
|  | MH Y+T-SPLITTER HOLDER | Modular universal holder for M12 T-splitter cordsets and M12 Y-splitter cordsets |
|  | MH V1-SCREWDRIVER | Torque screwdriver (0.6 Nm) |
|  | MH V1-BIT M12 | plug-in cap M12 |
|  | V1/V3-LABELHOLDER | Label holder |
|  | V1/V3-LABEL | Label plate |
|  | MH V1-Holder | Modular universal holder for M12 connectors |
|  | V1-CLIP | Unlocking protector for M12 connector |
|  | V1-MARKING-RING-COLOR | Marking rings for M12 connectors, various colors |