



Splitter boxes

V1-8/16A-E2

- Fast, simple installation with cage clamp terminals
- Twin communication of the plug-in stations
- LED indicator for module supply and I/O status

Splitter box octuple, twin configuration, with cage-clamp terminals



Dimensions

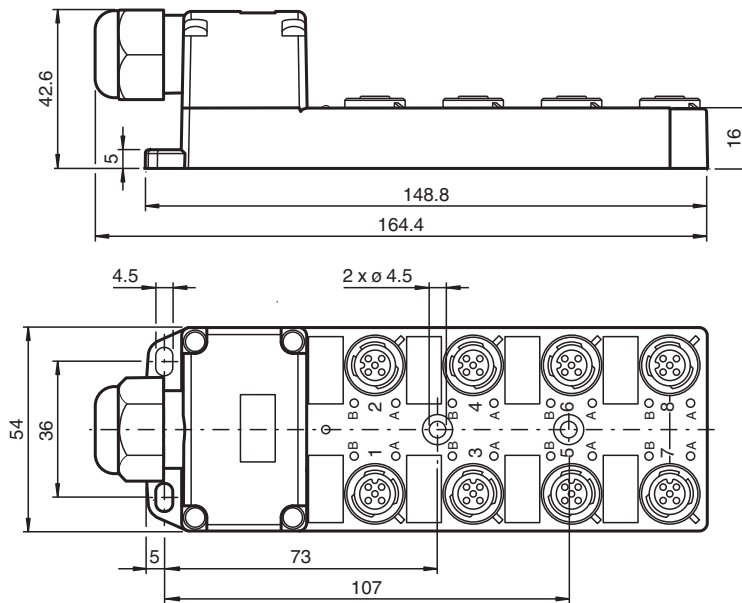

Technical Data

General specifications

Number of pins	5
UL File Number	E191152

Indicators/operating means

LED green	supply voltage each module
LED yellow	I/O status indication

Electrical specifications

Operating voltage	U_B	max. 24 V DC -20 % / +25 %
Operating current	I_B	≤ 5 mA per channel indication element

Technical Data

Current loading capacity	≤ 2 A per channel, ≤ 4 A per plug-in station, ≤ 8 A total current per distributor
Output	
Number/Type	8 , twin configuration
Conformity	
Degree of protection	EN 60529
Flammability	UL 94
Ambient conditions	
Ambient temperature	-25 ... 80 °C (-13 ... 176 °F)
Mechanical specifications	
Connection type	8 x socket M12 x 1 5-pin 1 x terminal compartment
Degree of protection	IP65/IP67
Connection	Signal and energy: Cage tension spring terminals flexible: 0.2 mm ² ... 1 mm ² rigid: 0.2 mm ² ... 1.5 mm ² Sensor/actuator: 5-pin, M12 x 1 socket
Material	
Contacts	Cu alloy
Contact surface	Au
Housing	PBT
Threaded bushings	PBT
Seal	O-ring: NBR
Cable	
Sheath diameter	7 mm ... 12 mm
Flammability	V-0

Connection

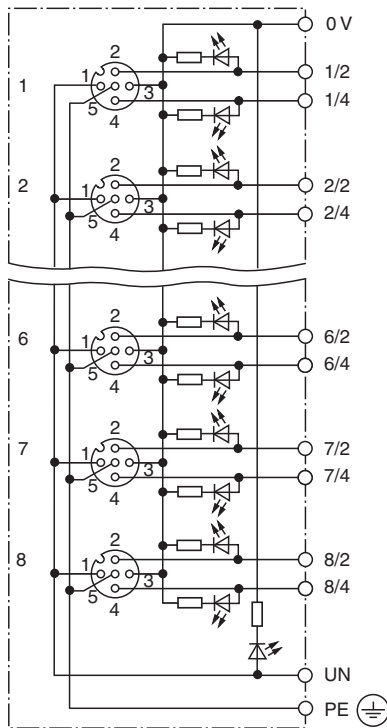



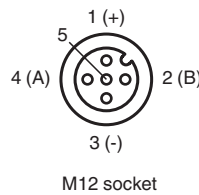

Slot/Pin (signal)	Terminal
1 / 4 (A)	1 / 4
1 / 2 (B)	1 / 2
2 / 4 (A)	2 / 4
2 / 2 (B)	2 / 2
3 / 4 (A)	3 / 4
3 / 2 (B)	3 / 2
4 / 4 (A)	4 / 4
4 / 2 (B)	4 / 2
5 / 4 (A)	5 / 4
5 / 2 (B)	5 / 2
6 / 4 (A)	6 / 4
6 / 2 (B)	6 / 2
7 / 4 (A)	7 / 4
7 / 2 (B)	7 / 2
8 / 4 (A)	8 / 4
8 / 2 (B)	8 / 2
1-8 / 1 (UN)	UN
1-8 / 3 (0 V)	0 V
1-8 / 5 (PE)	PE



Release date: 2023-04-13 Date of issue: 2023-04-13 Filename: 259974_eng.pdf

Accessories

	MH 05-SACB-8	Mounting aid for splitter boxes for DIN rail
	V15S-Y-V15/V15	Y-Splitter M12 plug to 2x M12 socket 5-pin A-coded
	MH V1-BIT M12	plug-in cap M12
	CBL-PUR-BK-16x050/3x100-50M	Cable, PUR/PVC, 19-core black, drag chain suitable, oil resistant
	VAZ-V1-B3L	Blind plug for M12 sockets