



Splitter boxes V1-8A-E2-5M-PUR

- LED indicator for module supply and I/O status
- UL Recognized Component
- Suitable for drag chains and abrasion resistant

Octuple splitter box with M12 connector with trunk cable



Dimensions

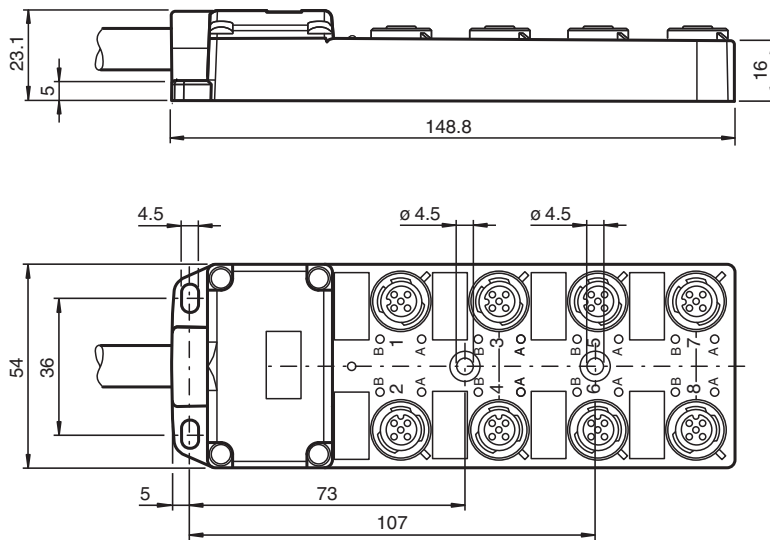

Technical Data

General specifications

Number of pins	4
UL File Number	E191152

Indicators/operating means

LED green	supply voltage each module
LED yellow	I/O status indication

Electrical specifications

Operating voltage	U_B	24 V DC, max. 30 V DC
Operating current	I_B	≤ 5 mA per channel indication element

Technical Data

Current loading capacity		≤ 2 A per channel, ≤ 4 A per plug-in station, ≤ 12 A total current per separator
Output		
Number/Type		8
Compliance with standards and directives		
Standard conformity		
Degree of protection		EN 60529
Flammability		DIN EN 50265-2-1
Ambient conditions		
Ambient temperature		housing: -25 ... 80 °C (-13 ... 176 °F) cable, flexing: -5 ... 80 °C (23 ... 176 °F) cable, fixed: -40 ... 90 °C (-40 ... 194 °F)
Mechanical specifications		
Connection type		8 x socket M12 x 1 4-pin Master cable
Degree of protection		IP65/IP67
Material		
Contacts		Cu alloy
Contact surface		Au
Housing		PBT
Threaded bushings		PBT
Cable		PUR
Seal		O-ring: NBR
Core insulation		PVC
Cable		
Sheath diameter		Ø 8.5 mm
Bending radius		> 10 x cable diameter, moving > 7.5 x cable diameter, fixed
Color		black
Coors		Signalling line (4): 8 x 0.34 mm ² (AWG 22) Supply line (1, 3), PE (5): 3 x 0.75 mm ² (AWG 18)
Conductor construction		19 x 0.15 mm Ø and 42 x 0.15 mm Ø
Length	L	5 m
Drag chain suitability		
Drag chain cycles		min. 1500000
Motion velocity		max. 2 m/s
Traverse distance		2 m
Mass		approx. 770 g



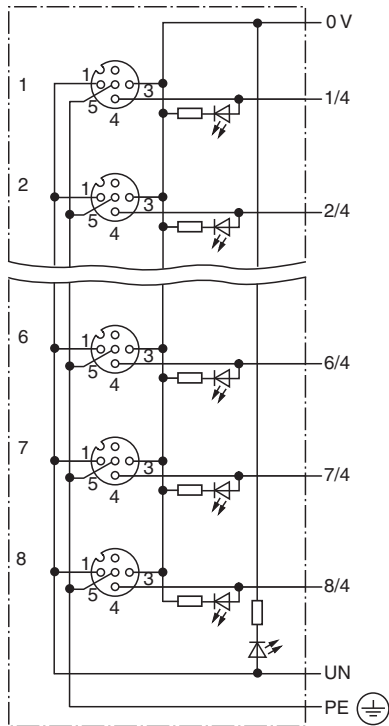

Connection

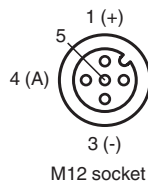

Slot/Pin (signal)	Color
1 / 4 (A)	WH
2 / 4 (A)	GN
3 / 4 (A)	YE
4 / 4 (A)	GY
5 / 4 (A)	PK
6 / 4 (A)	RD
7 / 4 (A)	BK
8 / 4 (A)	VT
1-8 / 1 (UN)	BN
1-8 / 3 (0 V)	BU
1-8 / 5 (PE)	GN/YE



Accessories

	MH 05-SACB-8	Mounting aid for splitter boxes for DIN rail
	MH V1-BIT M12	plug-in cap M12
	MH V1-SCREWDRIVER	torque screwdriver (0.6 Nm)
	VAZ-V1-B3L	Blind plug for M12 sockets