



HART Loop Converter

KFD2-HLC-Ex1.D

- 1-channel isolated barrier
- 24 V DC supply (Power Rail)
- HART field device input with transmitter power supply
- Usable as signal splitter (1 input and several outputs)
- 3 analog outputs 4 mA ... 20 mA
- Sink and source mode output
- Configurable by keypad



Function

This isolated barrier is used for intrinsic safety applications. It is a HART loop converter that provides power to transmitters or can be connected to existing HART loops in parallel. It is able to evaluate up to four HART variables (PV, SV, TV, QV). Of those four HART variables, the data contained in any three of them can be converted to three different 4 mA ... 20 mA current signals. These loop signals can be connected to display devices or analog inputs on the process control system/ control system. The unit is easily programmed by the use of a keypad located on the front of the unit or with the PACTware™ configuration software. For additional information, refer to the manual and www.pepperl-fuchs.com.

Connection

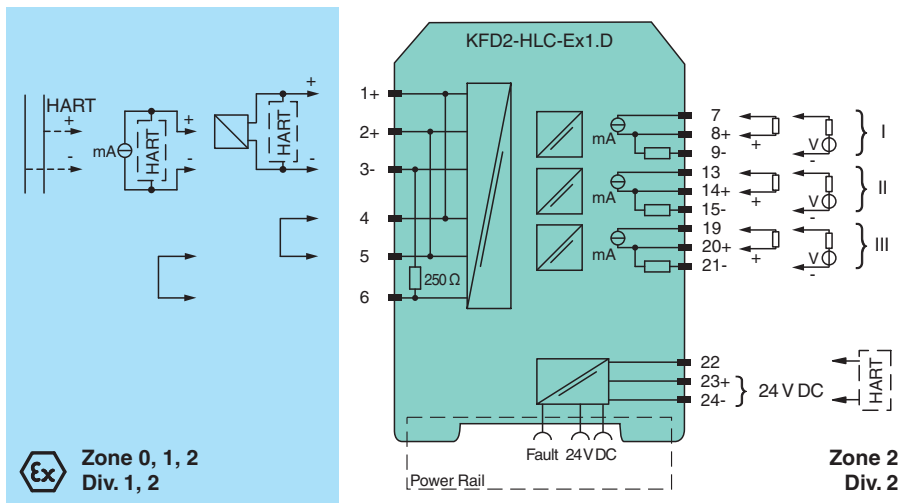

Technical Data

General specifications	
Signal type	Analog input
Supply	
Connection	Power Rail or terminals 23+, 24-
Rated voltage	U_r 19 ... 30 V DC
Rated current	I_r approx. 120 mA at 24 V DC
Power dissipation	2.3 W
Power consumption	2.9 W
HART signal channels (intrinsically safe)	
Conformity	HART field device input (revision 5 to 7)

Release date: 2023-04-06 Date of issue: 2023-04-06 Filename: 261916_eng.pdf

Technical Data

Interface	
Programming interface	programming socket
Input	
Connection side	field side
Connection	terminals 1, 2, 3, 4, 5, 6
Open circuit voltage/short-circuit current	typ. 24 V / 28 mA
Input resistance	250 Ω , 5 % (terminals 2, 3 and with jumper on 5, 6)
Available voltage	≥ 15.5 V at 20 mA, short-circuit protected
Output	
Connection side	control side
Connection	output I: terminals 7, 8, 9 , output II: terminals 13, 14, 15 , output III: terminals 19, 20, 21
Output signal	analog
Voltage range	5 ... 30 V , sink mode from external supply
Current range	4 ... 20 mA , (source or sink mode)
Load	max. 650 Ω , source mode
Fault signal	downscale I ≤ 2 mA, upscale I ≥ 21.5 mA (acc. NAMUR NE43) or hold measurement value
Other outputs	HART communicator on terminals 22, 24
Collective error message	Power Rail and LED red
Transfer characteristics	
Output I, II, III	
Resolution	max. 2 μ A
Accuracy	< 20 μ A, 10 μ A typ.
Influence of ambient temperature	< ± 2 μ A/K
Duration of measurement/Response delay	HART message acquisition time plus 100 ms
Galvanic isolation	
Output I/II/III/power supply	functional insulation acc. to IEC 62103, rated insulation voltage 50 V _{eff}
Indicators/settings	
Display elements	LEDs , display
Control elements	Control panel
Configuration	via operating buttons via PACTware
Labeling	space for labeling at the front
Directive conformity	
Electromagnetic compatibility	
Directive 2014/30/EU	EN 61326-1:2013 (industrial locations)
Low voltage	
Directive 2014/35/EU	EN 61010-1:2010
Conformity	
Electromagnetic compatibility	
Degree of protection	NE 21:2006
Degree of protection	
	IEC 60529:2001
Ambient conditions	
Ambient temperature	-20 ... 60 °C (-4 ... 140 °F)
Mechanical specifications	
Degree of protection	IP20
Connection	screw terminals
Mass	300 g
Dimensions	40 x 119 x 115 mm (1.6 x 4.7 x 4.5 inch) (W x H x D) , housing type C2
Mounting	on 35 mm DIN mounting rail acc. to EN 60715:2001
Data for application in connection with hazardous areas	
EU-type examination certificate	BASEEFA 07 ATEX 0174
Marking	Ⓜ II (1)G [Ex ia Ga] IIC Ⓜ II (1)D [Ex ia Da] IIIC







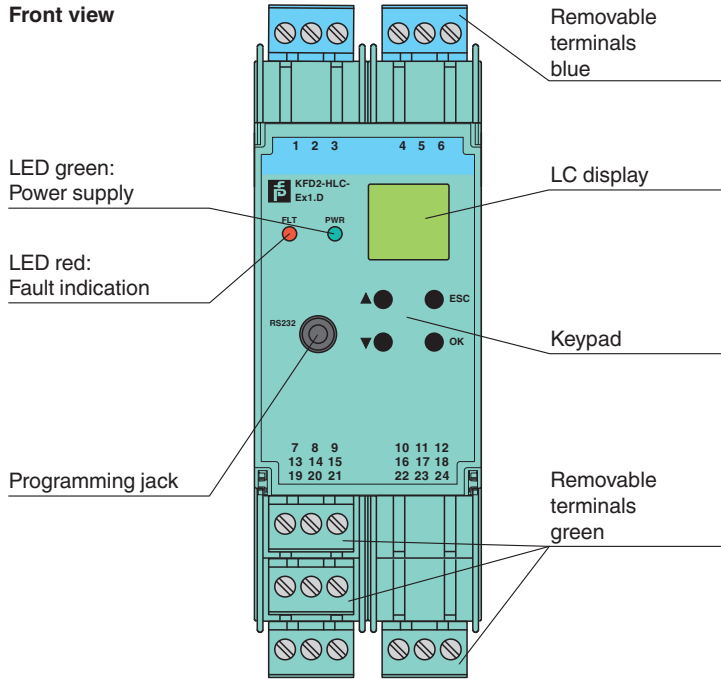

Technical Data

Supply		
Maximum safe voltage	U_m	253 V AC (Attention! The rated voltage can be lower.)
Equipment		
Voltage	U_o	25.2 V
Current	I_o	104.9 mA
Power	P_o	0.661 W
Internal capacitance	C_i	1.1 nF
Internal inductance	L_i	0 mH
Equipment		
terminals 2, 5/3		
Voltage	U_i	< 28 V
Power	P_i	< 1.33 W
Voltage	U_o	1.1 V
Current	I_o	11.9 mA
Power	P_o	4 mW
Internal capacitance	C_i	0 μ F
Internal inductance	L_i	0 mH
Output I, II, III		
terminals 7, 8, 9; 13, 14, 15; 19, 20, 21 non-intrinsically safe		
Maximum safe voltage	U_m	253 V (Attention! U_m is no rated voltage.)
Certificate		
PF 07 CERT 1142 X		
Marking		
Ⓜ II 3G Ex nA IIC T4 Gc		
Galvanic isolation		
Input/Other circuits safe electrical isolation acc. to IEC/EN 60079-11, voltage peak value 375 V		
Directive conformity		
Directive 2014/34/EU EN IEC 60079-0:2018+AC:2020 , EN 60079-11:2012 , EN 60079-15:2010		
International approvals		
FM approval		
Control drawing		116-0129
IECEX approval		
IECEX certificate		IECEX BAS 07.0047
IECEX marking		[Ex ia Ga] IIC , [Ex ia Da] IIIC
General information		
Supplementary information	Observe the certificates, declarations of conformity, instruction manuals, and manuals where applicable. For information see www.pepperl-fuchs.com .	



Assembly



Matching System Components



	DTM HART Loop converter	Device type manager (DTM) for HART communication
	PACTware 5.0	FDT Framework
	KFD2-EB2	Power Feed Module
	UPR-03	Universal Power Rail with end caps and cover, 3 conductors, length: 2 m
	UPR-03-M	Universal Power Rail with end caps and cover, 3 conductors, length: 1,6 m
	UPR-03-S	Universal Power Rail with end caps and cover, 3 conductors, length: 0.8 m
	K-DUCT-BU	Profile rail, wiring comb field side, blue
	K-DUCT-BU-UPR-03	Profile rail with UPR-03- * insert, 3 conductors, wiring comb field side, blue

Accessories

	K-250R	Measuring resistor
	K-500R0%1	Measuring resistor

Release date: 2023-04-06 Date of issue: 2023-04-06 Filename: 261916_eng.pdf

Accessories

	KF-ST-5GN	Terminal block for KF modules, 3-pin screw terminal, green
	KF-ST-5BU	Terminal block for KF modules, 3-pin screw terminal, blue
	KF-CP	Red coding pins, packaging unit: 20 x 6

Application

- Configurable as primary or secondary master
- Automatic HART burst supported
- Support for a HART handheld device connected on safe area side
- Can be configured to assign the same input variable to multiple outputs (signal splitting)