

Switch Amplifier

KFD2-ST3-Ex1.LB

- 1-channel isolated barrier
- 24 V DC supply (Power Rail)
- Dry contact or NAMUR inputs
- 2 active transistor outputs
- Usable as signal splitter (1 input and 2 outputs)
- Reversible mode of operation
- Line fault detection (LFD)
- Up to SIL 2 (SC 3) acc. to IEC/EN 61508



Function

This isolated barrier is used for intrinsic safety applications. The device transfers digital signals (NAMUR sensors or dry contacts) from a hazardous area to a safe area. The input controls two active transistor outputs. Via switches the mode of operation can be reversed and the line fault detection can be switched off. Via switch the function of the second output can be defined as a signal output or an error output. A fault is signaled by LEDs acc. to NAMUR NE44 and a separate collective error message output.

Connection

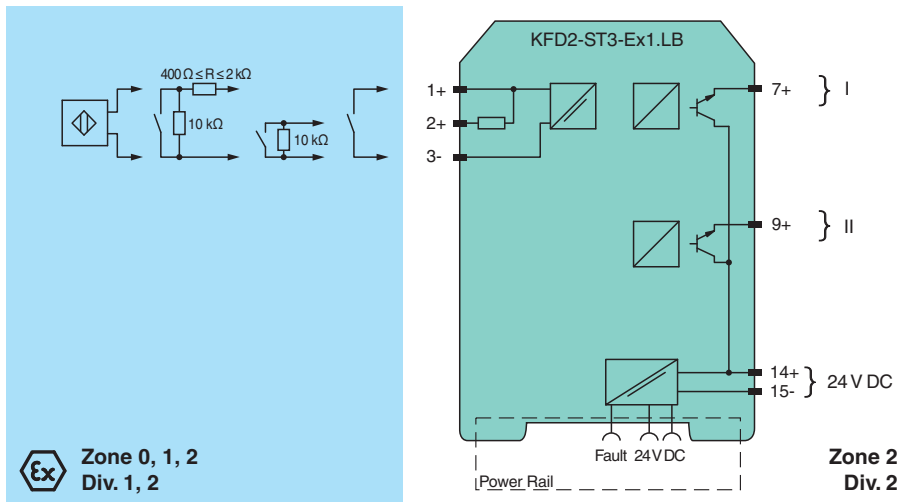

Technical Data

General specifications	
Signal type	Digital Input
Functional safety related parameters	
Safety Integrity Level (SIL)	SIL 2
Systematic capability (SC)	SC 3
Supply	
Connection	Power Rail or terminals 14+, 15-
Rated voltage	U_r 19 ... 30 V DC

Release date: 2023-01-03 Date of issue: 2023-01-03 Filename: 262110_eng.pdf

Technical Data

Ripple		≤ 10 %
Rated current	I_r	15 ... 10 mA + I_{out}
Power dissipation		≤ 800 mW including maximum power dissipation in the output
Input		
Connection side		field side
Connection		terminals 1+, 2+, 3-
Rated values		acc. to EN 60947-5-6 (NAMUR), see manual for electrical data
Open circuit voltage/short-circuit current		approx. 10 V DC / approx. 8 mA
Switching point/switching hysteresis		1.2 ... 2.1 mA / approx. 0.2 mA
Line fault detection		breakage $I \leq 0.1$ mA , short-circuit $I \geq 6.5$ mA
Pulse/Pause ratio		min. 100 μ s / min. 100 μ s
Output		
Connection side		control side
Connection		output I: terminal 7+ ; output II: terminal 9+
Rated voltage	U_r	30 V DC
Rated current	I_r	100 mA
Response time		≤ 200 μ s
Signal level		1-signal: (supply voltage) - 3 V max. for 100 mA 0-signal: blocked output (off-state current ≤ 10 μ A)
Output I		signal ; Transistor
Output II		signal or fault message ; Transistor
Collective error message		Power Rail
Transfer characteristics		
Switching frequency		≤ 5 kHz
Galvanic isolation		
Input/Output		reinforced insulation according to IEC/EN 61010-1, rated insulation voltage 300 V_{eff}
Input/power supply		reinforced insulation according to IEC/EN 61010-1, rated insulation voltage 300 V_{eff}
Indicators/settings		
Display elements		LEDs
Control elements		DIP switch
Configuration		via DIP switches
Labeling		space for labeling at the front
Directive conformity		
Electromagnetic compatibility		
Directive 2014/30/EU		EN 61326-1:2013 (industrial locations)
Conformity		
Electromagnetic compatibility		NE 21:2012 , EN 61326-3-2:2008
Degree of protection		IEC 60529:2001
Input		EN 60947-5-6:2000
Ambient conditions		
Ambient temperature		-20 ... 60 °C (-4 ... 140 °F)
Mechanical specifications		
Degree of protection		IP20
Connection		screw terminals
Mass		approx. 150 g
Dimensions		20 x 119 x 115 mm (0.8 x 4.7 x 4.5 inch) (W x H x D) , housing type B2
Mounting		on 35 mm DIN mounting rail acc. to EN 60715:2001
Data for application in connection with hazardous areas		
EU-type examination certificate		EXA 16 ATEX 0016 X
Marking		⊕ II 3(1)G Ex nA [ia Ga] IIC T4 Gc ⊕ II (1)D [Ex ia Da] IIIC ⊕ I (M1) [Ex ia Ma] I
Input		Ex ia
Voltage	U_o	10.5 V



Technical Data

Current	I_o	17.1 mA
Power	P_o	45 mW (linear characteristic)
Supply		
Maximum safe voltage	U_m	253 V AC (Attention! U_m is no rated voltage.)
Output		
Maximum safe voltage	U_m	253 V AC (Attention! The rated voltage can be lower.)
Galvanic isolation		
Input/Output		safe electrical isolation acc. to IEC/EN 60079-11, voltage peak value 375 V
Input/power supply		safe electrical isolation acc. to IEC/EN 60079-11, voltage peak value 375 V
Directive conformity		
Directive 2014/34/EU		EN IEC 60079-0:2018+AC:2020 , EN 60079-11:2012 , EN 60079-15:2010
International approvals		
UL approval		E106378
Control drawing		116-0424 (cULus)
IECEx approval		
IECEx certificate		IECEx EXA 16.0009X
IECEx marking		Ex nA [ia Ga] IIC T4 Gc , [Ex ia Da] IIIC , [Ex ia Ma] I
General information		
Supplementary information		Observe the certificates, declarations of conformity, instruction manuals, and manuals where applicable. For information see www.pepperl-fuchs.com .

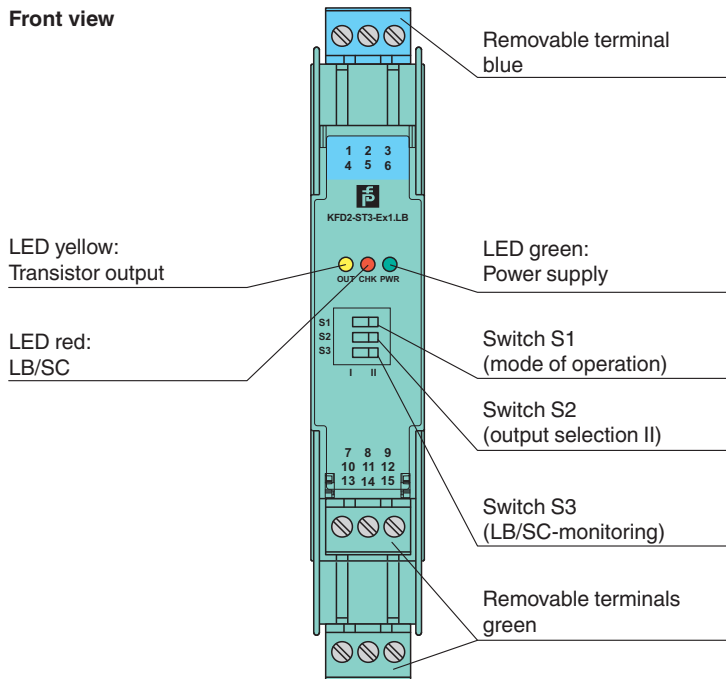
Assembly







Matching System Components





	KFD2-EB2	Power Feed Module
	UPR-03	Universal Power Rail with end caps and cover, 3 conductors, length: 2 m

Release date: 2023-01-03 Date of issue: 2023-01-03 Filename: 262110_eng.pdf

Matching System Components

	UPR-03-M	Universal Power Rail with end caps and cover, 3 conductors, length: 1,6 m
	UPR-03-S	Universal Power Rail with end caps and cover, 3 conductors, length: 0.8 m
	K-DUCT-BU	Profile rail, wiring comb field side, blue
	K-DUCT-BU-UPR-03	Profile rail with UPR-03- * insert, 3 conductors, wiring comb field side, blue

Accessories

	F-NR3-Ex1	NAMUR Resistor Network
	KF-ST-5GN	Terminal block for KF modules, 3-pin screw terminal, green
	KF-ST-5BU	Terminal block for KF modules, 3-pin screw terminal, blue
	KF-CP	Red coding pins, packaging unit: 20 x 6

Configuration

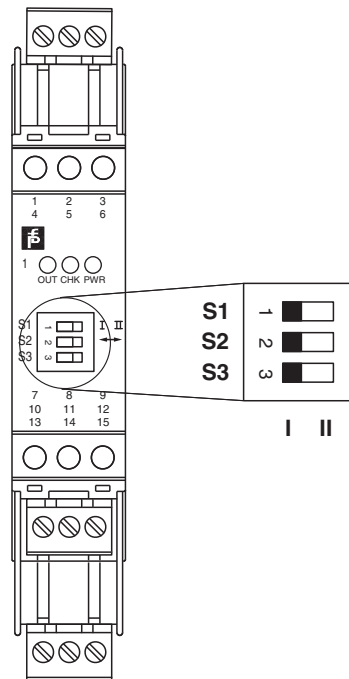

Switch position

S	Function		Position
1	Mode of operation output I active	with high input current	I
		with low input current	II
2	Assignment output II	Switching state like output I	I
		Fault indication output (passive if fault)	II
3	Line fault detection	ON	I
		OFF	II

Operating states

Control circuit	Input signal
Initiator high impedance/contact opened	low input current
Initiator low impedance/contact closed	high input current
Lead breakage, lead short circuit	Line fault

Factory setting: switch 1, 2 and 3 in position I

Release date: 2023-01-03 Date of issue: 2023-01-03 Filename: 262110_eng.pdf