

# Thru-beam sensor (pair)

## OBE500-R2F-SE2-0,2M-V31

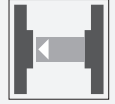

- Very flat design for direct mounting without mounting bracket
- Very bright, highly visible light spot

Thru-beam sensor, flat design, space-saving M2 mounting, 500 mm detection range, red light, dark on, PNP output, with 0.2 m fixed cable and M8 plug, 4-pin



### Dimensions

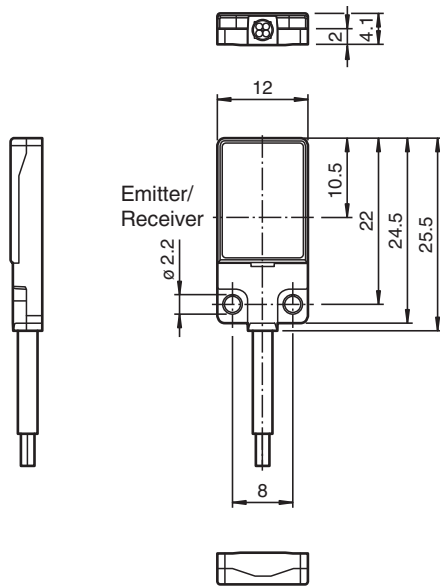

### Technical Data

System components	
Emitter	OBE500-R2F-S-0,2M-V31
Receiver	OBE500-R2F-E2-0,2M-V31
General specifications	
Effective detection range	0 ... 500 mm
Threshold detection range	700 mm
Light source	LED
Light type	modulated visible red light , 630 nm

Release date: 2023-03-28 Date of issue: 2023-03-28 Filename: 263381\_eng.pdf

## Technical Data

LED risk group labelling		exempt group
Angle deviation		approx. 2 °
Object size		typ. starts from 1.5 mm
Diameter of the light spot		approx. 90 mm at a distance of 500 mm
Opening angle		approx. 5 °
Optical face		frontal
Ambient light limit		EN 60947-5-2 : 25000 Lux
<b>Functional safety related parameters</b>		
MTTF <sub>d</sub>		806 a
Mission Time (T <sub>M</sub> )		20 a
Diagnostic Coverage (DC)		0 %
<b>Indicators/operating means</b>		
Operation indicator		LED green, statically lit Power on , short-circuit : LED green flashing (approx. 4 Hz)
Function indicator		Receiver: LED yellow, lights up when light beam is free, flashes when falling short of the operating reserve ; OFF when light beam is interrupted
<b>Electrical specifications</b>		
Operating voltage	U <sub>B</sub>	10 ... 30 V DC
No-load supply current	I <sub>0</sub>	Emitter: ≤ 11 mA Receiver: ≤ 8 mA
Protection class		III
<b>Input</b>		
Test input		Test of switching function at 0 V
<b>Output</b>		
Switching type		NO contact / dark-on
Signal output		1 PNP output, short-circuit protected, reverse polarity protected, open collector
Switching voltage		max. 30 V DC
Switching current		max. 50 mA , resistive load
Voltage drop	U <sub>d</sub>	≤ 1.5 V DC
Switching frequency	f	approx. 1 kHz
Response time		500 μs
<b>Conformity</b>		
Product standard		EN 60947-5-2
<b>Approvals and certificates</b>		
UL approval		E87056 , cULus Recognized, Class 2 Power Source
CCC approval		CCC approval / marking not required for products rated ≤36 V
<b>Ambient conditions</b>		
Ambient temperature		-20 ... 60 °C (-4 ... 140 °F)
Storage temperature		-20 ... 70 °C (-4 ... 158 °F)
<b>Mechanical specifications</b>		
Housing width		12 mm
Housing height		25.5 mm
Housing depth		4.1 mm
Degree of protection		IP67
Connection		200 mm fixed cable with 4-pin, M8x1 connector
Material		
Housing		PC (Polycarbonate) and Stainless steel
Optical face		PMMA
Cable		PUR
Mass		approx. 10 g per sensor
Tightening torque, fastening screws		0.25 Nm
Cable length		200 mm

## Connection

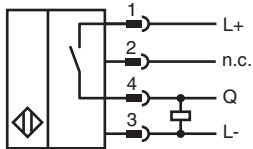
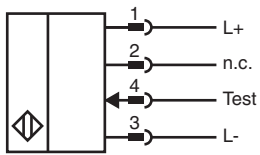

## Connection Assignment



Wire colors in accordance with EN 60947-5-2

1	BN	(brown)
2	WH	(white)
3	BU	(blue)
4	BK	(black)

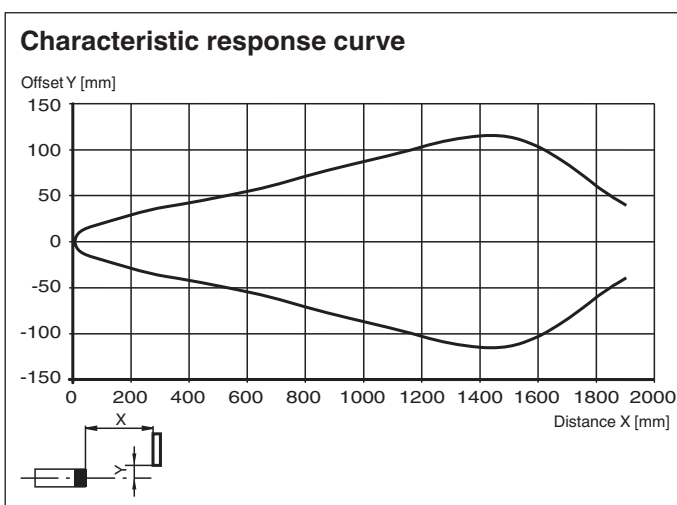

## Characteristic Curve

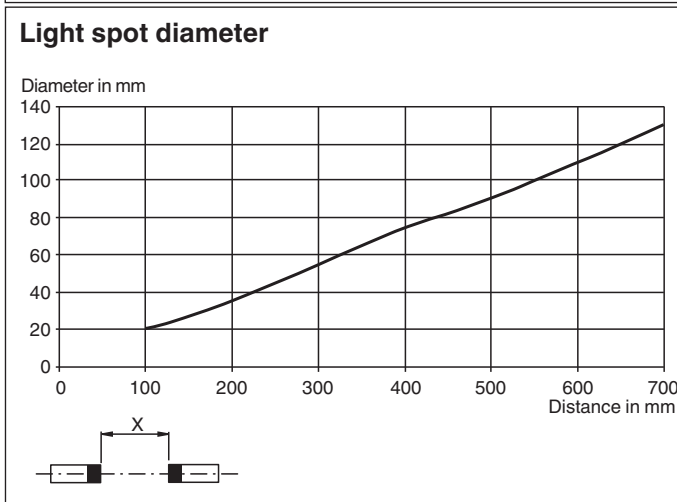
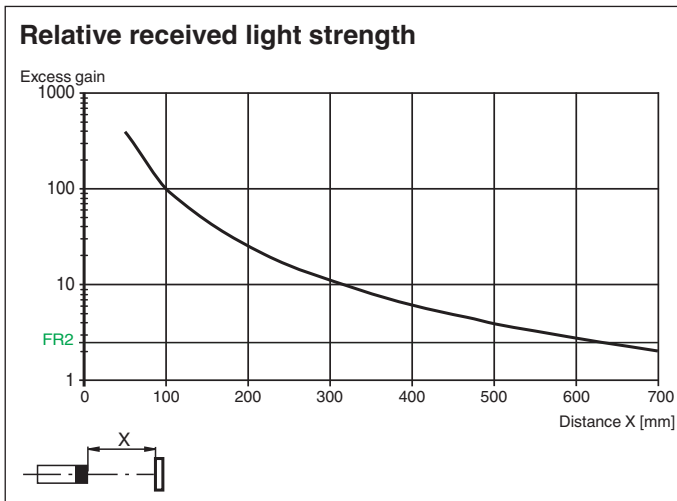

### Characteristic Curve



### Accessories

	<b>V31-GM-2M-PUR</b>	Female cordset single-ended M8 straight A-coded, 4-pin, PUR cable grey
	<b>V31-WM-2M-PUR</b>	Female cordset single-ended M8 angled A-coded, 4-pin, PUR cable grey

Release date: 2023-03-28 Date of issue: 2023-03-28 Filename: 263381\_eng.pdf