

Laser retroreflective sensor

OBR1500-R3F-E2-L

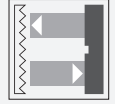

- Very flat design for direct mounting without mounting bracket
- DuraBeam Laser Sensors - durable and employable like an LED
- Glare protected with polarization filter
- Very bright, highly visible light spot

Retroreflective sensor, flat design, M3 mounting, 1500 mm detection range, red light, dark on, PNP output, fixed cable



Dimensions

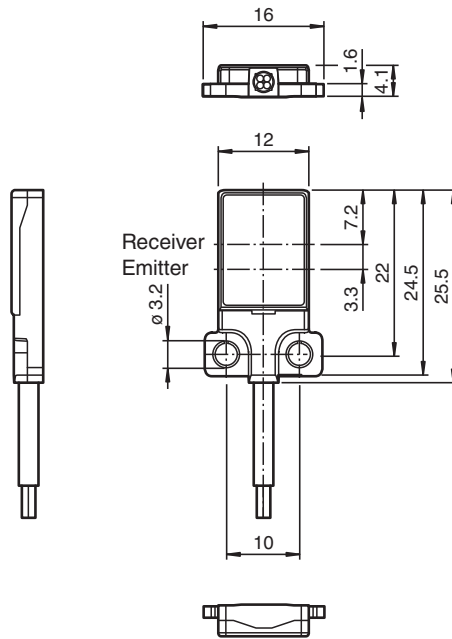

Technical Data

General specifications	
Effective detection range	0 ... 1500 mm
Reflector distance	60 ... 1500 mm
Threshold detection range	1800 mm
Reference target	H40 reflector
Light source	LASER LIGHT
Light type	modulated visible red light , 680 nm
Polarization filter	yes
Laser nominal ratings	

Release date: 2023-04-05 Date of issue: 2023-04-05 Filename: 263500_eng.pdf

Technical Data

Note	LASER LIGHT , DO NOT STARE INTO BEAM	
Laser class		1
Wave length		680 nm
Beam divergence		> 5 mrad
Pulse length		approx. 3 μ s
Repetition rate		approx. 16.6 kHz
max. pulse energy		8 nJ
Angle deviation		approx. 0.5 °
Object size		typ. starts from 1.5 mm
Diameter of the light spot		approx. 25 mm at a distance of 1500 mm
Opening angle		approx. 1 °
Optical face		frontal
Ambient light limit		EN 60947-5-2 : 30000 Lux
Functional safety related parameters		
MTTF _d		800 a
Mission Time (T _M)		20 a
Diagnostic Coverage (DC)		0 %
Indicators/operating means		
Operation indicator		LED green, statically lit Power on , short-circuit : LED green flashing (approx. 4 Hz)
Function indicator		Receiver: LED yellow, lights up when light beam is free, flashes when falling short of the operating reserve ; OFF when light beam is interrupted
Electrical specifications		
Operating voltage	U _B	12 ... 24 V
No-load supply current	I ₀	< 10 mA
Protection class		III
Output		
Switching type		NO contact / dark-on
Signal output		1 PNP output, short-circuit protected, reverse polarity protected, open collector
Switching voltage		max. 30 V DC
Switching current		max. 50 mA , resistive load
Voltage drop	U _d	≤ 1.5 V DC
Switching frequency	f	approx. 2 kHz
Response time		250 μ s
Conformity		
Product standard		EN 60947-5-2
Laser safety		EN 60825-1:2007
Approvals and certificates		
UL approval		E87056 , cULus Recognized, Class 2 Power Source
CCC approval		CCC approval / marking not required for products rated ≤36 V
FDA approval		IEC 60825-1:2007 Complies with 21 CFR 1040.10 and 1040.11 except for deviations pursuant to Laser Notice No. 50, dated June 24, 2007
Ambient conditions		
Ambient temperature		-10 ... 60 °C (14 ... 140 °F)
Storage temperature		-20 ... 70 °C (-4 ... 158 °F)
Mechanical specifications		
Housing width		16 mm
Housing height		25.5 mm
Housing depth		4.1 mm
Degree of protection		IP67
Connection		2 m fixed cable
Material		
Housing		PC (Polycarbonate) and Stainless steel
Optical face		PMMA
Cable		PUR

Technical Data

Mass	approx. 20 g
Tightening torque, fastening screws	1 Nm
Cable length	2 m

Connection

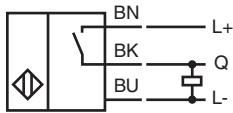

Characteristic Curve

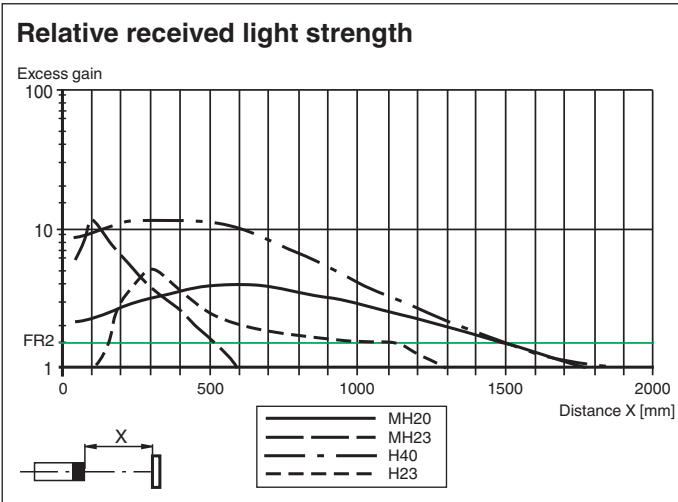
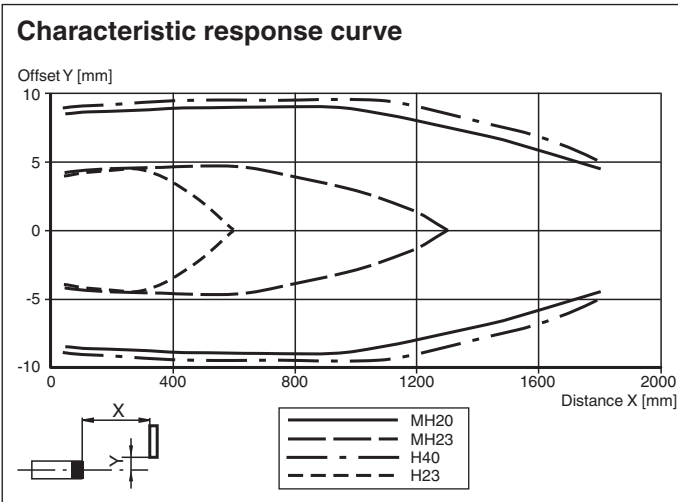

Release date: 2023-04-05 Date of issue: 2023-04-05 Filename: 263500_eng.pdf

Characteristic Curve

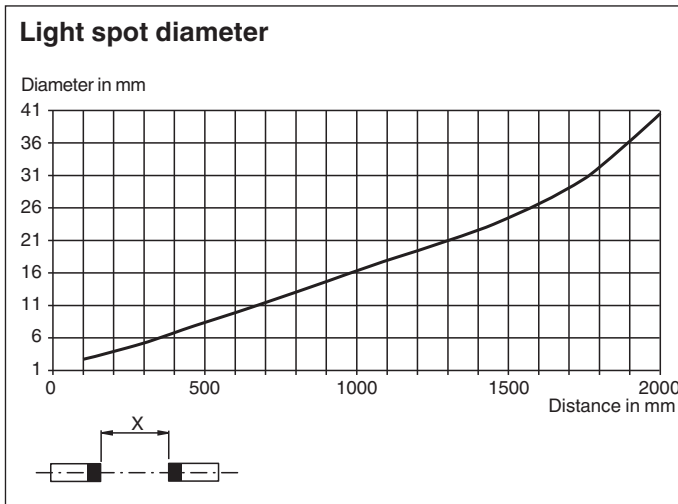

Safety Information

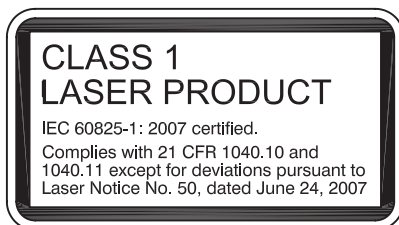

Safety Information

Laser Class 1 Information



The irradiation can lead to irritation especially in a dark environment. Do not point at people!
 Maintenance and repairs should only be carried out by authorized service personnel!
 Attach the device so that the warning is clearly visible and readable.
 The warning accompanies the device and should be attached in immediate proximity to the device.
 Caution – Use of controls or adjustments or performance of procedures other than those specified herein may result in hazardous radiation exposure.

Accessories

	REF-H40	Reflector, rectangular 47.5 mm x 23.5 mm, mounting holes, fixing strap
	REF-H23	Reflector with mounting holes

Release date: 2023-04-05 Date of issue: 2023-04-05 Filename: 263500_eng.pdf

Accessories

	REF-MH20	Reflector with Micro-structure, rectangular 32 mm x 20 mm, mounting holes
	REF-MH23	Reflector with Micro-structure, rectangular 23 mm x 13.8 mm, diagonal mounting hole