



Triangulation sensor (BGS)

OBT300-R101-2EP-IO-V31-L



- Miniature design with versatile mounting options
- DuraBeam Laser Sensors - durable and employable like an LED
- Extended temperature range
-40 °C ... 60 °C
- High degree of protection IP69K
- IO-Link interface for service and process data

Laser diffuse mode sensor with adjustable background suppression



Function

The miniature optical sensors are the first devices of their kind to offer an end-to-end solution in a small single standard design — from thru-beam sensor through to a distance measurement device. As a result of this design, the sensors are able to perform practically all standard automation tasks.

The DuraBeam laser sensors are durable and can be used in the same way as a standard sensor.

The use of Multi Pixel Technology gives the standard sensors a high level of flexibility and enables them to adapt more effectively to their operating environment.

Dimensions

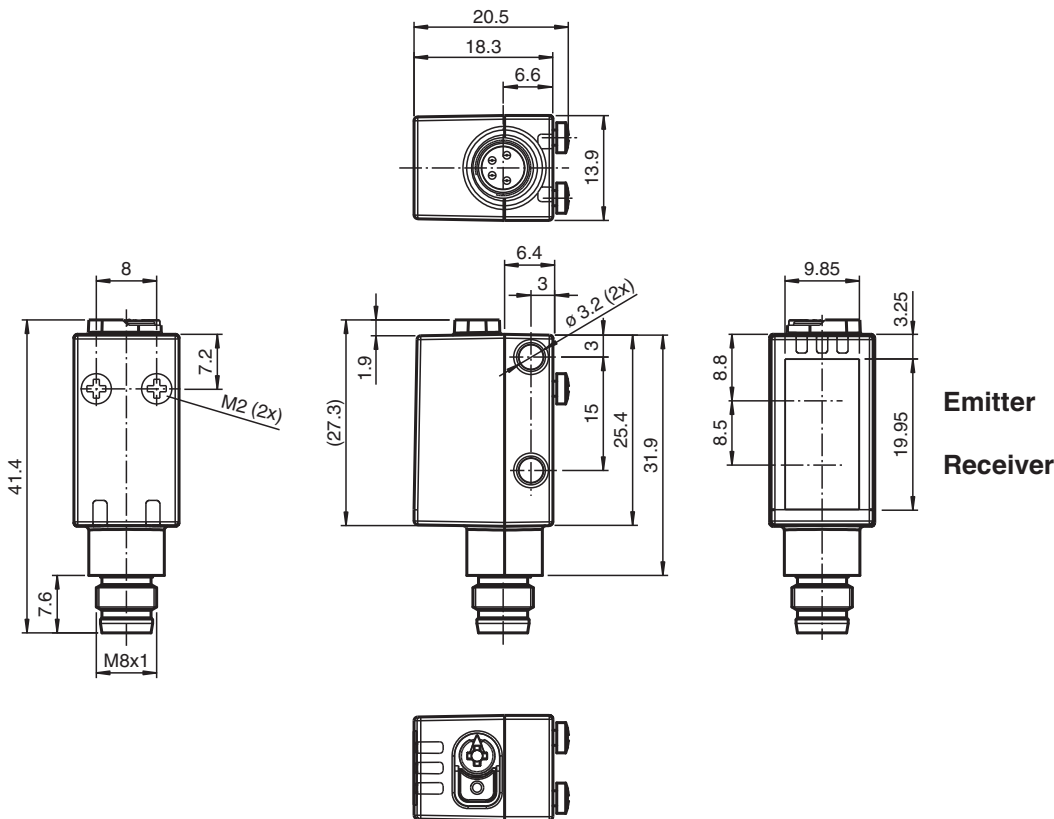

Release date: 2023-04-05 Date of issue: 2023-04-05 Filename: 267075-0061_eng.pdf

Technical Data

General specifications

Technical Data

Detection range	7 ... 300 mm	
Detection range min.	7 ... 25 mm	
Detection range max.	7 ... 300 mm	
Adjustment range	25 ... 300 mm	
Reference target	standard white, 100 mm x 100 mm	
Light source	laser diode	
Light type	modulated visible red light	
Laser nominal ratings		
Note	LASER LIGHT , DO NOT STARE INTO BEAM	
Laser class	1	
Wave length	680 nm	
Beam divergence	> 5 mrad d63 < 1 mm in the range of 150 mm ... 250 mm	
Pulse length	3 μ s	
Repetition rate	approx. 13 kHz	
max. pulse energy	10.4 nJ	
Black-white difference (6 %/90 %)	< 5 % at 150 mm	
Diameter of the light spot	approx. 1 mm at a distance of 200 mm	
Opening angle	approx. 0.3 °	
Ambient light limit	EN 60947-5-2 : 40000 Lux	
Functional safety related parameters		
MTTF _d	560 a	
Mission Time (T _M)	20 a	
Diagnostic Coverage (DC)	0 %	
Indicators/operating means		
Operation indicator	LED green: constantly on - power on flashing (4Hz) - short circuit flashing with short break (1 Hz) - IO-Link mode	
Function indicator	LED yellow: constantly on - object detected constantly off - object not detected	
Control elements	Light-on/dark-on changeover switch	
Control elements	Sensing range adjuster	
Electrical specifications		
Operating voltage	U _B	10 ... 30 V DC
Ripple	max. 10 %	
No-load supply current	I ₀	< 20 mA at 24 V supply voltage
Protection class	III	
Interface		
Interface type	IO-Link (via C/Q = pin 4)	
IO-Link revision	1.1	
Device profile	Smart Sensor	
Device ID	0x110602 (1115650)	
Transfer rate	COM2 (38.4 kBit/s)	
Min. cycle time	2.3 ms	
Process data width	Process data input 1 Bit Process data output 2 Bit	
SIO mode support	yes	
Compatible master port type	A	
Output		
Switching type	The switching type of the sensor is adjustable. The default setting is: C/Q - Pin4: NPN normally open / light-on, PNP normally closed / dark-on, IO-Link /Q - Pin2: NPN normally closed / dark-on, PNP normally open / light-on	
Signal output	2 push-pull (4 in 1) outputs, short-circuit protected, reverse polarity protected, overvoltage protected	
Switching voltage	max. 30 V DC	

Technical Data

Switching current		max. 100 mA , resistive load
Usage category		DC-12 and DC-13
Voltage drop	U_d	≤ 1.5 V DC
Switching frequency	f	1650 Hz
Response time		300 μ s
Conformity		
Communication interface		IEC 61131-9
Product standard		EN 60947-5-2
Laser safety		EN 60825-1:2014
Approvals and certificates		
UL approval		E87056 , cULus Listed , class 2 power supply , type rating 1
FDA approval		IEC 60825-1:2007 Complies with 21 CFR 1040.10 and 1040.11 except for deviations pursuant to Laser Notice No. 50, dated June 24, 2007
Ambient conditions		
Ambient temperature		-40 ... 60 °C (-40 ... 140 °F)
Storage temperature		-40 ... 70 °C (-40 ... 158 °F)
Mechanical specifications		
Housing width		13.9 mm
Housing height		41.4 mm
Housing depth		18.3 mm
Degree of protection		IP67 / IP69 / IP69K
Connection		M8 x 1 connector, 4-pin
Material		
Housing		PC (Polycarbonate)
Optical face		PMMA
Mass		approx. 10 g

Connection

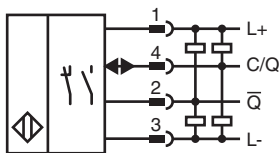

Connection Assignment



Wire colors in accordance with EN 60947-5-2

1	BN	(brown)
2	WH	(white)
3	BU	(blue)
4	BK	(black)

Assembly

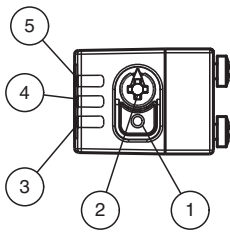

1	Light-on/dark-on changeover switch
2	Sensing range adjuster
3	Operating indicator / dark on
4	Signal indicator
5	Operating indicator / light on

Characteristic Curve

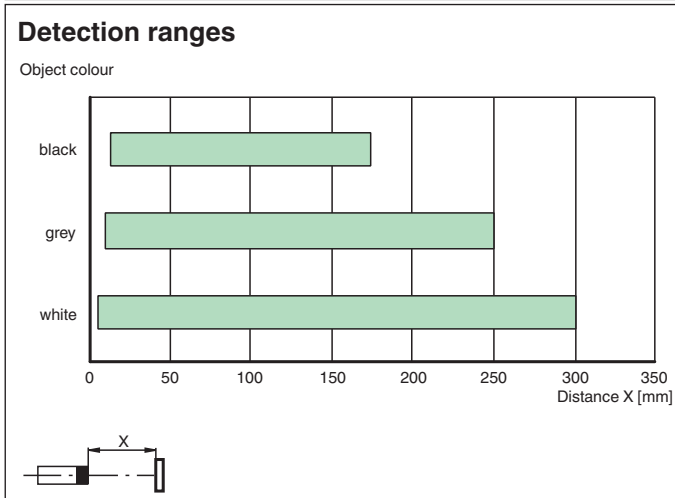
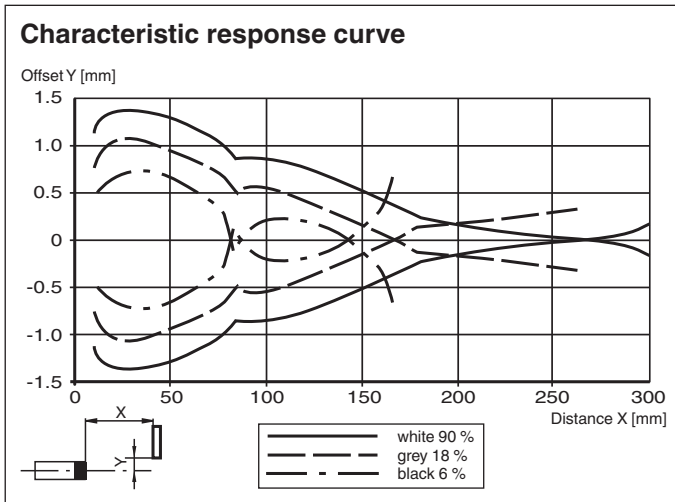

Release date: 2023-04-05 Date of issue: 2023-04-05 Filename: 267075-0061_eng.pdf

Characteristic Curve

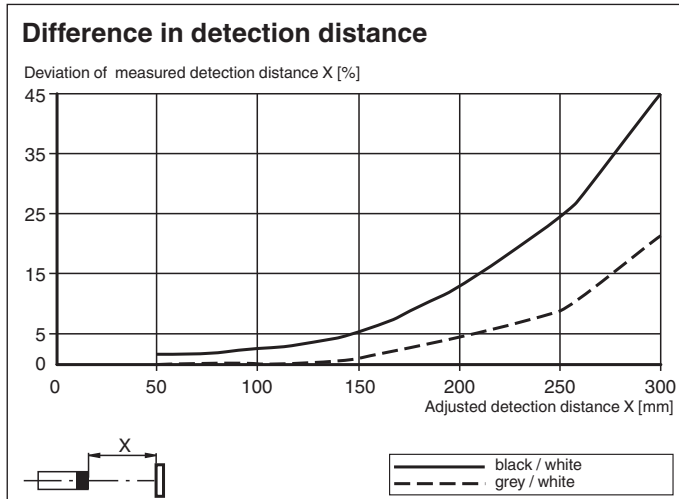



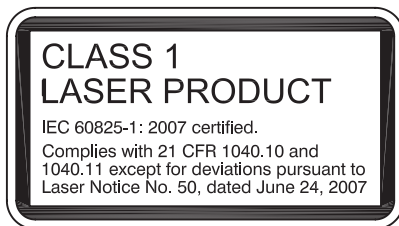

Safety Information









Release date: 2023-04-05 Date of issue: 2023-04-05 Filename: 267075-0061_eng.pdf

Accessories

	V31-GM-2M-PUR	Female cordset single-ended M8 straight A-coded, 4-pin, PUR cable grey
	V31-WM-2M-PUR	Female cordset single-ended M8 angled A-coded, 4-pin, PUR cable grey
	ICE2-8IOL-G65L-V1D	EtherNet/IP IO-Link master with 8 inputs/outputs
	ICE3-8IOL-G65L-V1D	PROFINET IO IO-Link master with 8 inputs/outputs

Accessories

	ICE1-8IOL-G30L-V1D	Ethernet IO-Link module with 8 inputs/outputs
	ICE1-8IOL-G60L-V1D	Ethernet IO-Link module with 8 inputs/outputs
	ICE2-8IOL-K45P-RJ45	EtherNet/IP IO-Link master with 8 inputs/outputs, DIN rail, push-in connectors
	ICE2-8IOL-K45S-RJ45	EtherNet/IP IO-Link master with 8 inputs/outputs, DIN rail, screw terminal
	ICE3-8IOL-K45P-RJ45	PROFINET IO IO-Link master with 8 inputs/outputs, DIN rail, push-in terminals
	ICE3-8IOL-K45S-RJ45	PROFINET IO IO-Link master with 8 inputs/outputs, DIN rail, screw terminal
	IO-Link-Master02-USB	IO-Link master, supply via USB port or separate power supply, LED indicators, M12 plug for sensor connection

Configuration



- 1 - Light on / dark on changeover switch
- 2 - Sensing range / sensitivity adjuster
- 3 - Operating indicator / dark on
- 4 - Signal indicator
- 5 - Operating indicator / light on

To unlock the adjustment functions turn the sensing range adjuster for more than 180 degrees.

Sensing Range / Sensitivity

Turn sensing range / sensitivity adjuster clockwise to increase sensing range / sensitivity.

Turn sensing range /sensitivity adjuster counterclockwise to decrease sensing range / sensitivity.

If the end of the adjustment range is reached, the signal indicator starts flashing with 8 Hz.

Light on / Dark on Configuration

Press the light on / dark on changeover switch for more than 1 second (less than 4 seconds). The light on / dark on mode changes and the operating indicators are activated accordingly.

If you press the light on / dark on changeover switch for more than 4 seconds, the light on / dark on mode changes back to the original setting. On release of the light on / dark on changeover switch the current state is activated.

Restore Factory Settings

Press the light on / dark on changeover switch for more than 10 seconds (less than 30 seconds) until all LEDs turn off. On release of the light on / dark on changeover switch the signal indicator turns on. After 5 seconds the sensor resumes operation with factory settings.

After 5 minutes of inactivity the sensing range / sensitivity adjustment is locked. In order to reactivate the sensing range / sensitivity adjustment, turn the sensing range / sensitivity adjuster for more than 180 degrees.