



Triangulation sensor (BGE) OBT350-R100-2EP-IO-0,3M-V1-1T



- Miniature design with versatile mounting options
- Precision object detection, almost irrespective of the color
- Secure and gapless detection, even near the surface through background evaluation
- Extended temperature range
-40 °C ... 60 °C
- High degree of protection IP69K
- IO-Link interface for service and process data

Triangulation sensor with background evaluation



Function

The R100 series miniature optical sensors are the first devices of their kind to offer an end-to-end solution in a small single standard design — from thru-beam sensor through to a distance measurement device. As a result of this design, the sensors are able to perform practically all standard automation tasks.

The entire series enables sensors to communicate via IO-Link.

The DuraBeam laser sensors are durable and can be used in the same way as a standard sensor.

The use of Multi Pixel Technology gives the standard sensors a high level of flexibility and enables them to adapt more effectively to their operating environment.

Dimensions

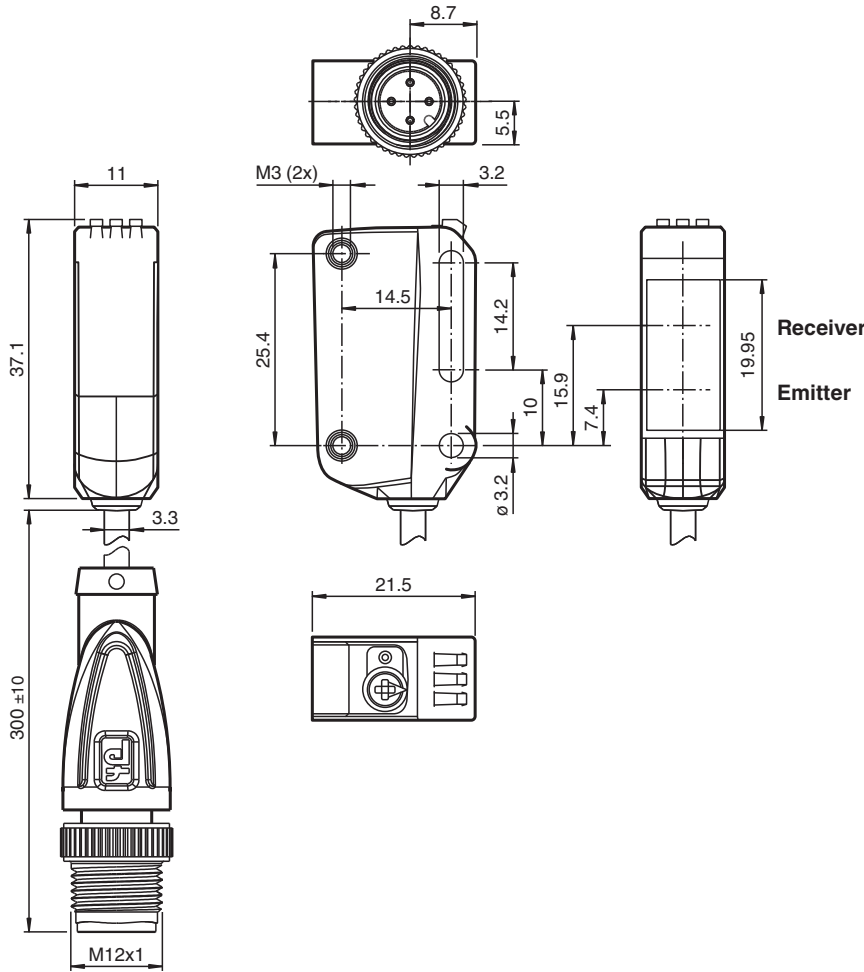

Technical Data

General specifications	
Detection range	5 ... 350 mm
Detection range min.	5 ... 25 mm
Detection range max.	5 ... 350 mm
Adjustment range	25 ... 350 mm
Reference target	standard white, 100 mm x 100 mm
Light source	LED
Light type	modulated visible red light
LED risk group labelling	exempt group
Black-white difference (6%/90%)	< 15 % at 350 mm
Diameter of the light spot	approx. 20 mm at a distance of 350 mm
Opening angle	approx. 3 °
Ambient light limit	EN 60947-5-2 : 40000 Lux
Functional safety related parameters	
MTTF _d	600 a
Mission Time (T _M)	20 a
Diagnostic Coverage (DC)	0 %
Indicators/operating means	
Operation indicator	LED green: constantly on - power on flashing (4Hz) - short circuit flashing with short break (1 Hz) - IO-Link mode

Release date: 2023-04-05 Date of issue: 2023-04-05 Filename: 267075-0083_eng.pdf

Technical Data

Function indicator	LED yellow: constantly on - background detected (object not detected) constantly off - object detected	
Control elements	Light-on/dark-on changeover switch	
Control elements	Sensing range adjuster	
Electrical specifications		
Operating voltage	U_B	10 ... 30 V DC
Ripple		max. 10 %
No-load supply current	I_0	< 25 mA at 24 V supply voltage
Protection class		III
Interface		
Interface type		IO-Link (via C/Q = pin 4)
IO-Link revision		1.1
Device profile		Smart Sensor
Device ID		0x110701 (1115905)
Transfer rate		COM2 (38.4 kBit/s)
Min. cycle time		2.3 ms
Process data width		Process data input 1 Bit Process data output 2 Bit
SIO mode support		yes
Compatible master port type		A
Output		
Switching type		The switching type of the sensor is adjustable. The default setting is: C/Q - Pin4: NPN normally open / dark-on, PNP normally closed / light-on, IO-Link /Q - Pin2: NPN normally closed / light-on, PNP normally open / dark-on
Signal output		2 push-pull (4 in 1) outputs, short-circuit protected, reverse polarity protected, overvoltage protected
Switching voltage		max. 30 V DC
Switching current		max. 100 mA , resistive load
Usage category		DC-12 and DC-13
Voltage drop	U_d	≤ 1.5 V DC
Switching frequency	f	500 Hz
Response time		1 ms
Conformity		
Communication interface		IEC 61131-9
Product standard		EN 60947-5-2
Approvals and certificates		
UL approval		E87056 , cULus Listed , class 2 power supply , type rating 1
Ambient conditions		
Ambient temperature		-40 ... 60 °C (-40 ... 140 °F) , fixed cable -25 ... 60 °C (-13 ... 140 °F) , movable cable not appropriate for conveyor chains
Storage temperature		-40 ... 70 °C (-40 ... 158 °F)
Mechanical specifications		
Housing width		11 mm
Housing height		37.1 mm
Housing depth		21.5 mm
Degree of protection		IP67 / IP69 / IP69K
Connection		300 mm fixed cable with M12 x 1, 4-pin connector
Material		
Housing		PC (Polycarbonate)
Optical face		PMMA
Mass		approx. 17 g
Cable length		0.3 m

Connection



Connection Assignment



Wire colors in accordance with EN 60947-5-2

- 1 | BN (brown)
- 2 | WH (white)
- 3 | BU (blue)
- 4 | BK (black)

Assembly

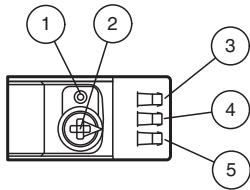





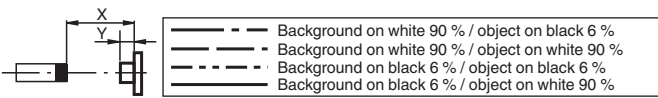
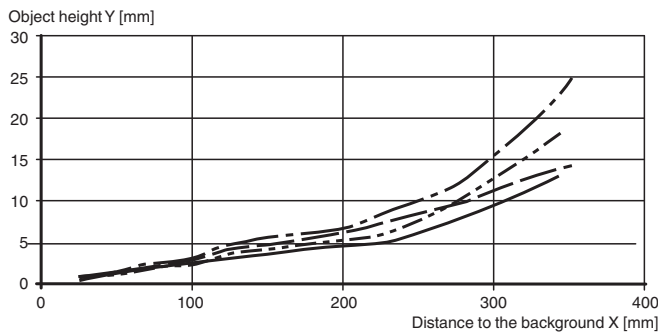















1	Light-on / dark-on changeover switch
2	Sensing range adjuster
3	Operating indicator / dark on
4	Signal indicator
5	Operating indicator / light on

Minimum object height



Release date: 2023-04-05 Date of issue: 2023-04-05 Filename: 267075-0083_eng.pdf

Accessories

	OMH-ML100-09	Mounting aid for round steel ø 12 mm or sheet 1.5 mm ... 3 mm
	V1-G-2M-PUR	Female cordset single-ended M12 straight A-coded, 4-pin, PUR cable grey
	V1-W-2M-PUR	Female cordset single-ended M12 angled A-coded, 4-pin, PUR cable grey
	OMH-R10X-01	Mounting bracket
	OMH-R10X-02	Mounting bracket
	OMH-R10X-04	Mounting bracket
	OMH-R10X-10	Mounting bracket
	OMH-ML100-03	Mounting aid for round steel ø 12 mm or sheet 1.5 mm ... 3 mm
	OMH-ML100-031	Mounting aid for round steel ø 10 ... 14 mm or sheet 1 mm ... 5 mm
	V31-GM-2M-PUR	Female cordset single-ended M8 straight A-coded, 4-pin, PUR cable grey
	V31-WM-2M-PUR	Female cordset single-ended M8 angled A-coded, 4-pin, PUR cable grey
	ICE2-8IOL-G65L-V1D	EtherNet/IP IO-Link master with 8 inputs/outputs
	ICE3-8IOL-G65L-V1D	PROFINET IO IO-Link master with 8 inputs/outputs
	ICE1-8IOL-G30L-V1D	Ethernet IO-Link module with 8 inputs/outputs
	ICE1-8IOL-G60L-V1D	Ethernet IO-Link module with 8 inputs/outputs
	ICE2-8IOL-K45P-RJ45	EtherNet/IP IO-Link master with 8 inputs/outputs, DIN rail, push-in connectors
	ICE2-8IOL-K45S-RJ45	EtherNet/IP IO-Link master with 8 inputs/outputs, DIN rail, screw terminal
	ICE3-8IOL-K45P-RJ45	PROFINET IO IO-Link master with 8 inputs/outputs, DIN rail, push-in terminals
	ICE3-8IOL-K45S-RJ45	PROFINET IO IO-Link master with 8 inputs/outputs, DIN rail, screw terminal
	IO-Link-Master02-USB	IO-Link master, supply via USB port or separate power supply, LED indicators, M12 plug for sensor connection

Release date: 2023-04-05 Date of issue: 2023-04-05 Filename: 267075-0083_eng.pdf

Configuration



- 1 - Light-on / dark-on changeover switch
- 2 - Sensing range / sensitivity adjuster
- 3 - Operating indicator / dark on
- 4 - Signal indicator
- 5 - Operating indicator / light on

To unlock the adjustment functions turn the sensing range /sensitivity adjuster for more than 180 degrees.

Sensing Range / Sensitivity

Turn sensing range / sensitivity adjuster clockwise to increase sensing range / sensitivity.

Turn sensing range / sensitivity adjuster counter clockwise to decrease sensing range / sensitivity.

If the end of the adjustment range is reached, the signal indicator starts flashing with 8 Hz.

Light-on / Dark-on Configuration

Press the light-on / dark-on changeover switch for more than 1 second (less than 4 seconds). The light-on / dark-on mode changes and the operating indicators are activated accordingly.

If you press the light-on / dark-on changeover switch for more than 4 seconds, the light-on /dark-on mode changes back to the original setting. On release of the light-on / dark-on changeover switch the current state is activated.

Restore Factory Settings

Press the light-on / dark-on changeover switch for more than 10 seconds (less than 30 seconds) until all LEDs turn off. On release of the light-on / dark-on changeover switch the signal indicator turns on. After 5 seconds the sensor resumes operation with factory default settings.

After 5 minutes of inactivity the sensing range / sensitivity adjustment is locked. In order to reactivate the sensing range / sensitivity adjustment, turn the sensing range /sensitivity adjuster for more than 180 degrees.