



Triangulation sensor (BGS) OBT300-R100-2EP-IO-0,3M-V1-L



- Miniature design with versatile mounting options
- DuraBeam Laser Sensors - durable and employable like an LED
- Extended temperature range
-40 °C ... 60 °C
- High degree of protection IP69K
- IO-Link interface for service and process data

Laser diffuse mode sensor with adjustable background suppression



Function

The R100 series miniature optical sensors are the first devices of their kind to offer an end-to-end solution in a small single standard design — from thru-beam sensor through to a distance measurement device. As a result of this design, the sensors are able to perform practically all standard automation tasks.

The entire series enables sensors to communicate via IO-Link.

The DuraBeam laser sensors are durable and can be used in the same way as a standard sensor.

The use of Multi Pixel Technology gives the standard sensors a high level of flexibility and enables them to adapt more effectively to their operating environment.

Dimensions

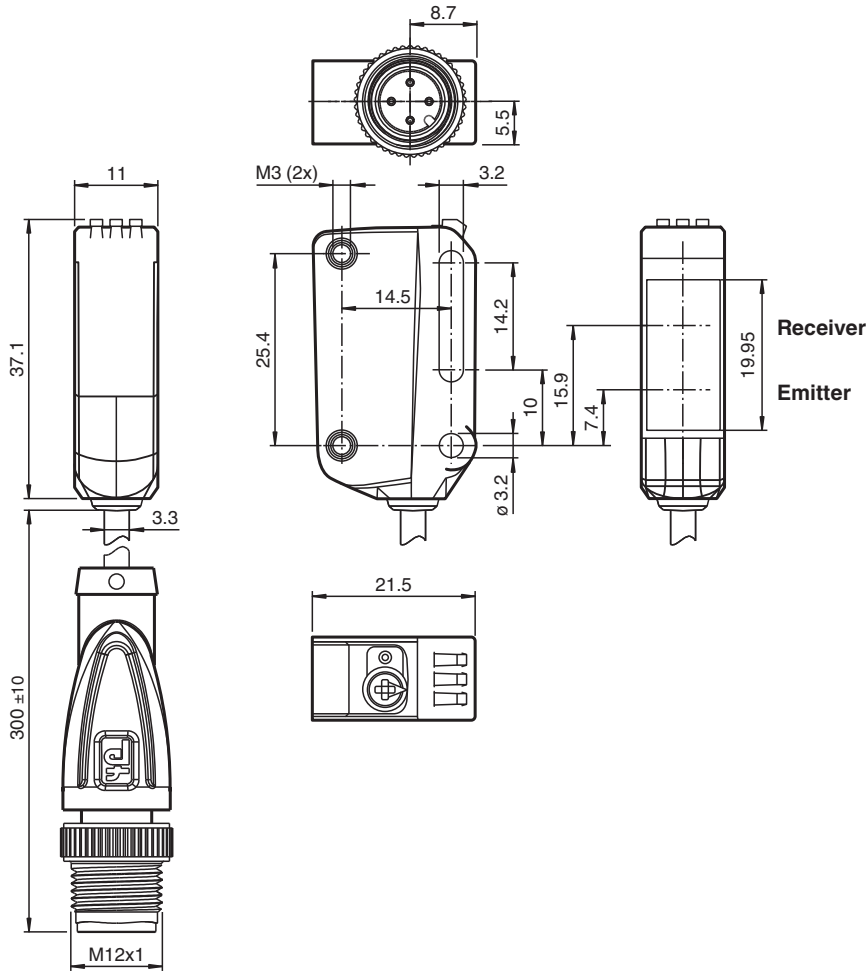

Technical Data

General specifications

Detection range	7 ... 300 mm
Detection range min.	7 ... 25 mm
Detection range max.	7 ... 300 mm
Adjustment range	25 ... 300 mm
Reference target	standard white, 100 mm x 100 mm
Light source	laser diode
Light type	modulated visible red light
Laser nominal ratings	
Note	LASER LIGHT , DO NOT STARE INTO BEAM
Laser class	1
Wave length	680 nm
Beam divergence	> 5 mrad d63 < 1 mm in the range of 150 mm ... 250 mm
Pulse length	3 µs
Repetition rate	approx. 13 kHz
max. pulse energy	10.4 nJ
Black-white difference (6 %/90 %)	< 5 % at 150 mm
Diameter of the light spot	approx. 1 mm at a distance of 200 mm
Opening angle	approx. 0.3 °
Ambient light limit	EN 60947-5-2 : 40000 Lux
Functional safety related parameters	
MTTF _d	560 a

Release date: 2025-01-17 Date of issue: 2025-01-17 Filename: 267075-0088_eng.pdf

Technical Data

Mission Time (T _M)		20 a
Diagnostic Coverage (DC)		0 %
Indicators/operating means		
Operation indicator		LED green: constantly on - power on flashing (4Hz) - short circuit flashing with short break (1 Hz) - IO-Link mode
Function indicator		LED yellow: constantly on - object detected constantly off - object not detected
Control elements		Light-on/dark-on changeover switch
Control elements		Sensing range adjuster
Electrical specifications		
Operating voltage	U _B	10 ... 30 V DC
Ripple		max. 10 %
No-load supply current	I ₀	< 20 mA at 24 V supply voltage
Protection class		III
Interface		
Interface type		IO-Link (via C/Q = pin 4)
IO-Link revision		1.1
Device profile		Smart Sensor
Device ID		0x110602 (1115650)
Transfer rate		COM2 (38.4 kBit/s)
Min. cycle time		2.3 ms
Process data width		Process data input 1 Bit Process data output 2 Bit
SIO mode support		yes
Compatible master port type		A
Output		
Switching type		The switching type of the sensor is adjustable. The default setting is: C/Q - Pin4: NPN normally open / light-on, PNP normally closed / dark-on, IO-Link /Q - Pin2: NPN normally closed / dark-on, PNP normally open / light-on
Signal output		2 push-pull (4 in 1) outputs, short-circuit protected, reverse polarity protected, overvoltage protected
Switching voltage		max. 30 V DC
Switching current		max. 100 mA , resistive load
Usage category		DC-12 and DC-13
Voltage drop	U _d	≤ 1.5 V DC
Switching frequency	f	1650 Hz
Response time		300 μs
Conformity		
Communication interface		IEC 61131-9
Product standard		EN 60947-5-2
Laser safety		EN 60825-1:2014
Approvals and certificates		
UL approval		E87056 , cULus Listed , class 2 power supply , type rating 1
FDA approval		IEC 60825-1:2014 Complies with 21 CFR 1040.10 and 1040.11 except for conformance with IEC 60825-1 Ed. 3 as described in Laser Notice 56, dated May 8, 2019.
Ambient conditions		
Ambient temperature		-40 ... 60 °C (-40 ... 140 °F) , cable, fixed installation -25 ... 60 °C (-13 ... 140 °F) , movable cable not appropriate for conveyor chains
Storage temperature		-40 ... 70 °C (-40 ... 158 °F)
Mechanical specifications		
Degree of protection		IP67 / IP69 / IP69K
Connection		300 mm fixed cable with M12 x 1, 4-pin connector
Material		

Technical Data

Housing	PC (Polycarbonate)
Optical face	PMMA
Mass	approx. 17 g
Dimensions	
Height	37.1 mm
Width	11 mm
Depth	21.5 mm
Cable length	0.3 m

Connection Assignment

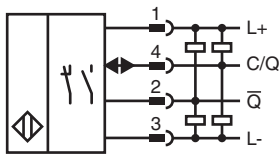

Connection Assignment

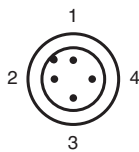

Wire colors in accordance with EN 60947-5-2

- 1 | BN (brown)
- 2 | WH (white)
- 3 | BU (blue)
- 4 | BK (black)

Assembly

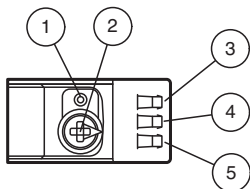

1	Light-on / dark-on changeover switch
2	Sensing range adjuster
3	Operating indicator / dark on
4	Signal indicator
5	Operating indicator / light on

Release date: 2025-01-17 Date of issue: 2025-01-17 Filename: 267075-0088_eng.pdf

Characteristic Curve

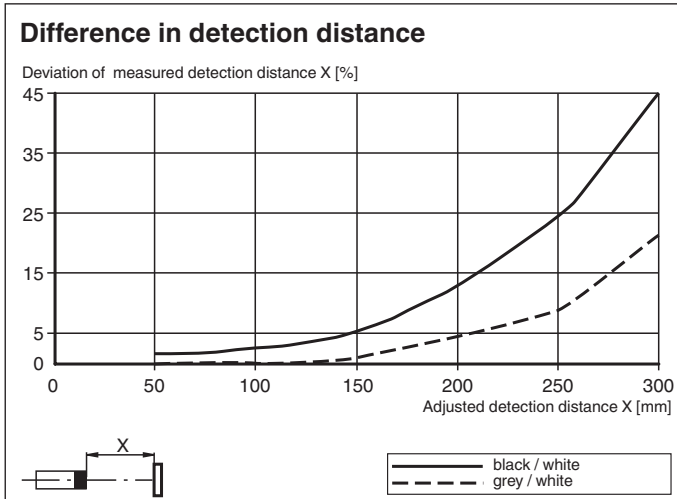
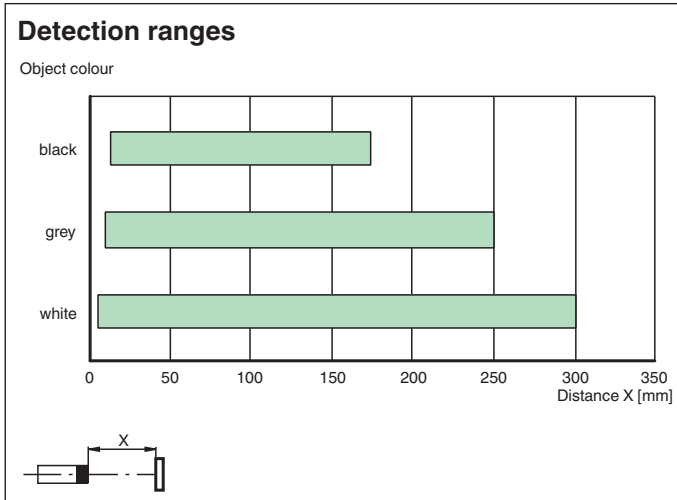
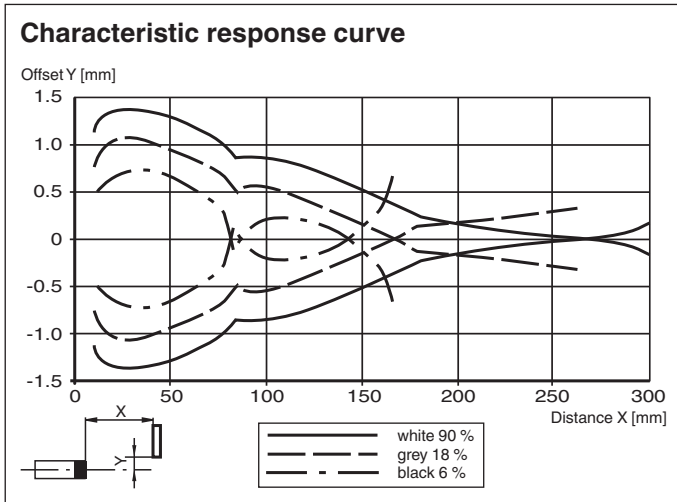

Release date: 2025-01-17 Date of issue: 2025-01-17 Filename: 267075-0088_eng.pdf

Safety Information



Release date: 2025-01-17 Date of issue: 2025-01-17 Filename: 267075-0088_eng.pdf

Configuration



- 1 - Light-on / dark-on changeover switch
- 2 - Sensing range / sensitivity adjuster
- 3 - Operating indicator / dark on
- 4 - Signal indicator
- 5 - Operating indicator / light on

To unlock the adjustment functions turn the sensing range /sensitivity adjuster for more than 180 degrees.

Sensing Range / Sensitivity

Turn sensing range / sensitivity adjuster clockwise to increase sensing range / sensitivity.

Turn sensing range / sensitivity adjuster counter clockwise to decrease sensing range / sensitivity.

If the end of the adjustment range is reached, the signal indicator starts flashing with 8 Hz.

Light-on / Dark-on Configuration

Press the light-on / dark-on changeover switch for more than 1 second (less than 4 seconds). The light-on / dark-on mode changes and the operating indicators are activated accordingly.

If you press the light-on / dark-on changeover switch for more than 4 seconds, the light-on /dark-on mode changes back to the original setting. On release of the light-on / dark-on changeover switch the current state is activated.

Restore Factory Settings

Press the light-on / dark-on changeover switch for more than 10 seconds (less than 30 seconds) until all LEDs turn off. On release of the light-on / dark-on changeover switch the signal indicator turns on. After 5 seconds the sensor resumes operation with factory default settings.

After 5 minutes of inactivity the sensing range / sensitivity adjustment is locked. In order to reactivate the sensing range / sensitivity adjustment, turn the sensing range /sensitivity adjuster for more than 180 degrees.